

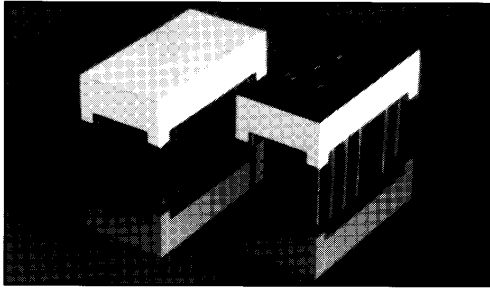

0.300-INCH SEVEN SEGMENT DISPLAYS

HIGH EFFICIENCY GREEN MAN3400A RED MAN70A
ORANGE MAN3600A YELLOW MAN3800A



DESCRIPTION

The MAN3400A, MAN3600A, MAN70A and MAN3800A Series provides a choice of color of LED displays. Standard units are available in Red, Green, Orange and Yellow. They can be mounted in arrays with 0.400-inch (10.16 mm) center-to-center spacing. Yellow and High Efficiency Green displays are constructed with Grey face and neutral segment color. Red displays have Black faces and Red segment color. Others have face and segment color corresponding to the emitted light.

FEATURES

- Common anode or common cathode models
- Red, Yellow, Green and Orange
- Fast switching — excellent for multiplexing
- Low power consumption
- Bold solid segments that are highly legible
- Solid state reliability — long operation life
- Impact resistant plastic construction
- Directly compatible with integrated circuits
- High brightness with high contrast
- Categorized for Luminous Intensity (See Note 6)
- Standard 14 pin dual-in-line package configuration
- Wide angle viewing ... 150°

APPLICATIONS

- Digital readout displays
- Instrument panels
- Point of sale equipment
- Calculators
- Digital clocks

MODEL NUMBERS

| PART NUMBER | COLOR | DESCRIPTION |
|-------------|-----------------------|------------------------------------|
| MAN3410A | High Efficiency Green | Common Anode; Right Hand Decimal |
| MAN3420A | High Efficiency Green | Common Anode; Left Hand Decimal |
| MAN3440A | High Efficiency Green | Common Cathode; Right Hand Decimal |
| MAN3610A | Orange | Common Anode; Right Hand Decimal |
| MAN3620A | Orange | Common Anode; Left Hand Decimal |
| MAN3630A | Orange | Common Anode; Overflow ±1 |
| MAN3640A | Orange | Common Cathode; Right Hand Decimal |
| MAN71A | Red | Common Anode; Right Hand Decimal |
| MAN72A | Red | Common Anode; Left Hand Decimal |
| MAN73A | Red | Common Anode; Overflow ±1 |
| MAN74A | Red | Common Cathode; Right Hand Decimal |
| MAN3810A | Yellow | Common Anode; Right Hand Decimal |
| MAN3820A | Yellow | Common Anode; Left Hand Decimal |
| MAN3840A | Yellow | Common Cathode; Right Hand Decimal |



0.300-INCH SEVEN SEGMENT DISPLAYS

| ELECTRO-OPTICAL CHARACTERISTICS (25°C Free Air Temperature Unless Otherwise Specified) | | | | | |
|--|------------|--------------|------|----------------------------------|---|
| | MIN. | TYP. | MAX. | UNITS | TEST CONDITIONS |
| MAN3410A, 3420A, 3440A | | | | | |
| Luminous Intensity, digit average (See Notes 1 and 3) | 750 900 | 3200 4000 | | μcd μcd | $I_f = 10 \text{ mA}$ $I_f = 60 \text{ mA peak, 1:6 DF}$ |
| Peak emission wavelength | | 562 | | nm | |
| Spectral line half width | | 30 | | nm | |
| Forward voltage | | | | | |
| Segment | | 2.2 | 3.0 | V | $I_f = 20 \text{ mA}$ |
| Decimal point | | 2.2 | 3.0 | V | $I_f = 20 \text{ mA}$ |
| Dynamic resistance | | | | | |
| Segment | | 12 | | Ω | $I_f = 20 \text{ mA}$ |
| Decimal point | | 12 | | Ω | $I_f = 20 \text{ mA}$ |
| Capacitance | | | | | |
| Segment | | 40 | | pF | $V = 0$ |
| Decimal point | | 40 | | pF | $V = 0$ |
| Reverse current | | | | | |
| Segment | | | 100 | μA | $V_R = 5.0 \text{ V}$ |
| Decimal point | | | 100 | μA | $V_R = 5.0 \text{ V}$ |
| MAN3610A, 3620A, 3630A, 3640A | | | | | |
| Luminous Intensity, digit average (See Note 1 and 3) | 510 | 1800 | | μcd | $I_f = 10 \text{ mA}$ |
| Peak emission wavelength | | 630 | | nm | |
| Spectral line half width | | 40 | | nm | |
| Forward voltage | | | | | |
| Segment | | | 2.5 | V | $I_f = 20 \text{ mA}$ |
| Decimal point | | | 2.5 | V | $I_f = 20 \text{ mA}$ |
| Dynamic resistance | | | | | |
| Segment | | 26 | | Ω | $I_f = 20 \text{ mA}$ |
| Decimal point | | 26 | | Ω | $I_f = 20 \text{ mA}$ |
| Capacitance | | | | | |
| Segment | | 35 | | pF | $V = 0$ |
| Decimal point | | 35 | | pF | $V = 0$ |
| Reverse current | | | | | |
| Segment | | | 100 | μA | $V_R = 5.0 \text{ V}$ |
| Decimal point | | | 100 | μA | $V_R = 5.0 \text{ V}$ |



0.300-INCH SEVEN SEGMENT DISPLAYS

| ELECTRO-OPTICAL CHARACTERISTICS (25°C Free Air Temperature Unless Otherwise Specified) (Cont'd) | | | | | |
|---|------|------|------|----------|-------------------|
| | MIN. | TYP. | MAX. | UNITS | TEST CONDITIONS |
| MAN71A, 72A, 73A, 74A | | | | | |
| Luminous Intensity, digit average (See Note 1 and 3) | 125 | 350 | | μ cd | $I_F = 10$ mA |
| Peak emission wavelength | | 660 | | nm | |
| Spectral line half width | | 20 | | nm | |
| Forward voltage | | | | | |
| Segment | | | 2.0 | V | $I_F = 20$ mA |
| Decimal point | | | 2.0 | V | $I_F = 20$ mA |
| Dynamic resistance | | | | | |
| Segment | | 2 | | Ω | $I_{pk} = 100$ mA |
| Decimal point | | 2 | | Ω | $I_{pk} = 100$ mA |
| Capacitance | | | | | |
| Segment | | 35 | 80 | pF | V=0 |
| Decimal point | | 35 | 80 | pF | V=0 |
| Reverse current | | | | | |
| Segment | | | 100 | μ A | $V_R = 5.0$ V |
| Decimal point | | | 100 | μ A | $V_R = 5.0$ V |
| MAN3810A, 3820A, 3840A | | | | | |
| Luminous Intensity, digit average (See Note 1 and 3) | 450 | 1700 | | μ cd | $I_F = 10$ mA |
| Peak emission wavelength | | 585 | | nm | |
| Spectral line half width | | 40 | | nm | |
| Forward voltage | | | | | |
| Segment | | | 3.0 | V | $I_F = 20$ mA |
| Decimal point | | | 3.0 | V | $I_F = 20$ mA |
| Dynamic resistance | | | | | |
| Segment | | 26 | | Ω | $I_F = 20$ mA |
| Decimal point | | 26 | | Ω | $I_F = 20$ mA |
| Capacitance | | | | | |
| Segment | | 35 | | pF | V=0 |
| Decimal point | | 35 | | pF | V=0 |
| Reverse current | | | | | |
| Segment | | | 100 | μ A | $V_R = 5.0$ V |
| Decimal point | | | 100 | μ A | $V_R = 5.0$ V |



0.300-INCH SEVEN SEGMENT DISPLAYS

| RECOMMENDED OPTICAL FILTERS | | | |
|---|--|--|--|
| For optimum ON and OFF contrast, one of the following filters or equivalents should be used over the display: | | | |
| DEVICE TYPE | FILTER | DEVICE TYPE | FILTER |
| MAN3610A } MAN3620A } MAN3630A } MAN3640A } | Panelgraphic Scarlet 65 Homalite 100-1670 | MAN71A } MAN72A } MAN73A } MAN74A } | Panelgraphic Red 60 Homalite 100-1605 |
| MAN3410A } MAN3420A } MAN3440A } | | Panelgraphic Green 48 Homalite 100-1440 Green | |

| ABSOLUTE MAXIMUM RATINGS | | | |
|---|----------------------------------|----------------------------------|----------------|
| | HIGH EFF. GREEN | RED | |
| | MAN3410A MAN3420A MAN3440A | MAN71A MAN72A MAN74A | MAN73A |
| Power dissipation at 25°C ambient | 600 mW | 480 mW | 300 mW |
| Derate linearly from 50°C | -12 mW/°C | -6.9 mW/°C | -4.29 mW/°C |
| Storage and operating temperature | -40°C to +85°C | -40°C to +85°C | -40°C to +85°C |
| Continuous forward current | | | |
| Total | 240 mA | 240 mA | 150 mA |
| Per segment | 30 mA | 30 mA | 30 mA |
| Decimal point | 30 mA | 30 mA | 30 mA |
| Reverse voltage | | | |
| Per segment | 6.0 V | 6.0 V | 6.0 V |
| Decimal point | 6.0 V | 6.0 V | 6.0 V |
| Soldering time at 260°C (See Notes 4 and 5) | 5 sec. | 5 sec. | 5 sec. |
| | YELLOW | ORANGE | |
| | MAN3810A MAN3820A MAN3840A | MAN3610A MAN3620A MAN3640A | MAN3630A |
| Power dissipation at 25°C ambient | 600 mW | 600 mW | 375 mW |
| Derate linearly from 50°C | -10.3 mW/°C | -8.6 mW/°C | -5.36 mW/°C |
| Storage and operating temperature | -40°C to +85°C | -40°C to +85°C | -40°C to +85°C |
| Continuous forward current | | | |
| Total | 200 mA | 240 mA | 150 mA |
| Per segment | 25 mA | 30 mA | 30 mA |
| Decimal point | 25 mA | 30 mA | 30 mA |
| Reverse voltage | | | |
| Per segment | 6.0 V | 6.0 V | 6.0 V |
| Decimal point | 6.0 V | 6.0 V | 6.0 V |
| Soldering time at 260°C (See Notes 4 and 5) | 5 sec. | 5 sec. | 5 sec. |

| TYPICAL THERMAL CHARACTERISTICS | |
|---|------------|
| GREEN/YELLOW | |
| Thermal resistance junction to free air Φ_{JA} | 160°C/W |
| Wavelength temperature coefficient (case temperature) | 1.0Å/°C |
| Forward voltage temperature coefficient | -1.5 mV/°C |
| RED/ORANGE | |
| Thermal resistance junction to free air Φ_{JA} | 160°C/W |
| Wavelength temperature coefficient (case temperature) | 1.0Å/°C |
| Forward voltage temperature coefficient | -2.0 mV/°C |

| NOTES |
|---|
| 1. The digit average Luminous Intensity is obtained by summing the Luminous Intensity of each segment and dividing by the total number of segments. Intensity will not vary more than $\pm 33.3\%$ between all segments within a digit. |
| 2. The curve in Figures 3, 6, 9, and 12 is normalized to the brightness at 25°C to indicate the relative Luminous Intensity over the operating temperature range. |
| 3. The decimal point is designed to have the same surface brightness as the segments, therefore, the Luminous Intensity of the decimal point is .3 times the Luminous Intensity of the segments, since the area of the decimal point is .3 times the area of the average segment. |
| 4. Leads of the device immersed to 1/16 inch from the body. Maximum device surface temperature is 140°C. |
| 5. For flux removal, Freon TF, Freon TE, Isoproponal or water may be used up to their boiling points. |
| 6. All displays are categorized for Luminous Intensity. The Intensity category is marked on each part as a suffix letter to the part number. |

PACKAGE DIMENSIONS

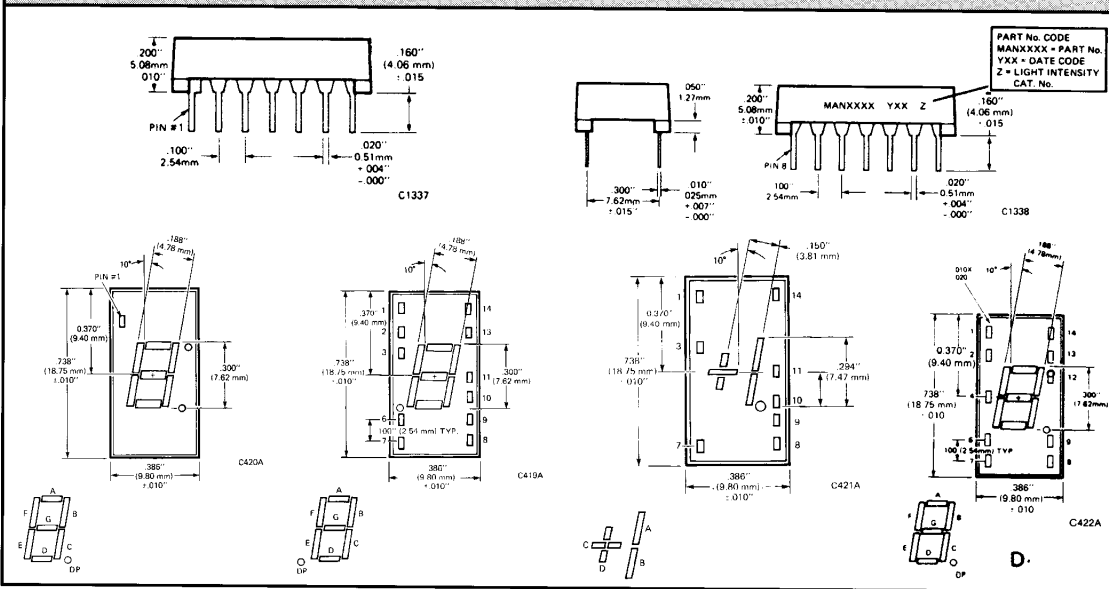

ELECTRICAL CONNECTIONS

| Pin No. | ELECTRICAL CONNECTIONS | | | |
|---------|----------------------------------|----------------------------------|--------------------|----------------------------------|
| | A MAN3410A, 3610A, 71A, 3810A | B MAN3420A, 72A, 3620A, 3820A | C MAN3630A, 73A | D MAN3440A, 3640A, 74A, 3840A |
| 1 | Cathode A | Cathode A | Anode C, D | Anode F |
| 2 | Cathode F | Cathode F | No Pin | Anode G |
| 3 | Common Anode | Common Anode | Anode C, D | No Pin |
| 4 | No Pin | No Pin | No Pin | Common Cathode |
| 5 | No Pin | No Pin | No Pin | No Pin |
| 6 | No Connection | Cathode D.P. | No Pin | Anode E |
| 7 | Cathode E | Cathode E | Cathode D | Anode D |
| 8 | Cathode D | Cathode D | Cathode C | Anode C |
| 9 | Cathode D.P. | No Connection | No Connection | Anode D.P. |
| 10 | Cathode C | Cathode C | Cathode B | No Pin |
| 11 | Cathode G | Cathode G | Cathode A | No Pin |
| 12 | No Pin | No Pin | No Pin | Common Cathode |
| 13 | Cathode B | Cathode B | No Pin | Anode B |
| 14 | Common Anode | Common Anode | Anode A, B | Anode A |

ELECTRICAL SCHEMATIC

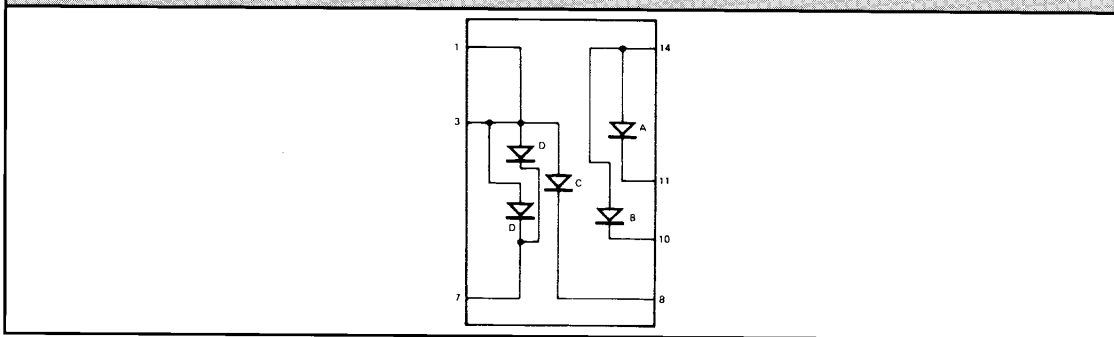

TYPICAL CHARACTERISTIC CURVES

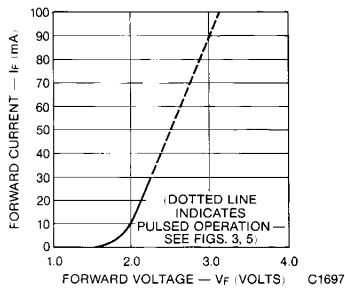

Fig. 1. Forward Current vs. Forward Voltage

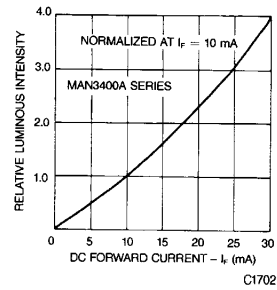

Fig. 2. Relative Luminous Intensity vs. DC Forward Current

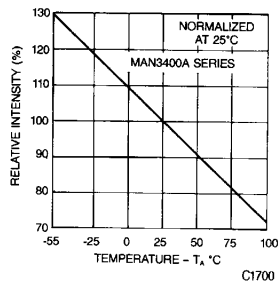

Fig. 3. Relative Luminous Intensity vs. Temperature

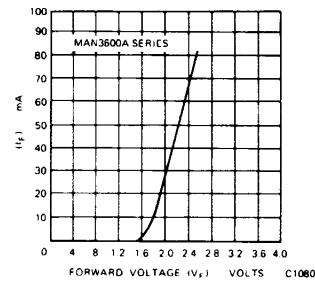

Fig. 4. Forward Current vs. Forward Voltage

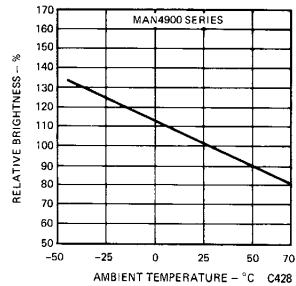

Fig. 5. Relative Luminous Intensity vs. Temperature

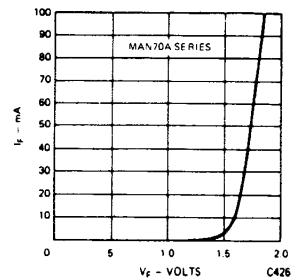

Fig. 6. Forward Current vs. Forward Voltage

TYPICAL CHARACTERISTIC CURVES (Cont'd)

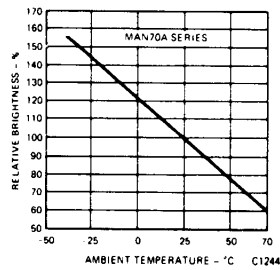

Fig. 7. Relative Luminous Intensity vs. Temperature

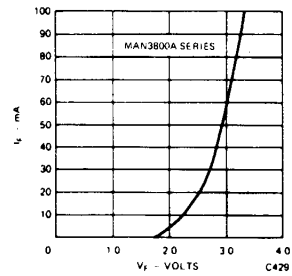

Fig. 8. Forward Current vs. Forward Voltage

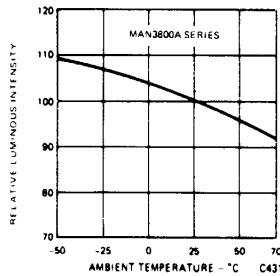

Fig. 9. Relative Luminous Intensity vs. Temperature

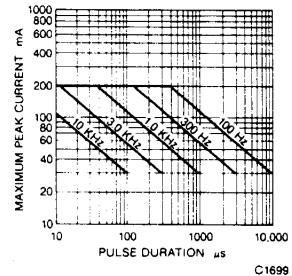

Fig. 10. Maximum Peak Current vs. Pulse Duration

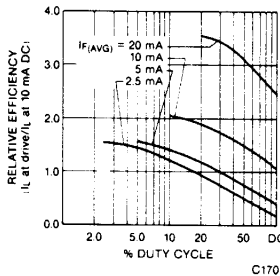

Fig. 11. Relative Efficiency vs. Duty Cycle

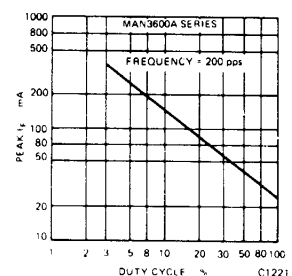

Fig. 12. Max Peak Current vs. Duty Cycle

TYPICAL CHARACTERISTIC CURVES (Cont'd)

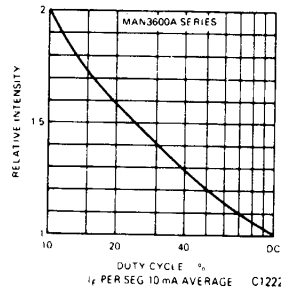

Fig. 13. Luminous Intensity vs. Duty Cycle

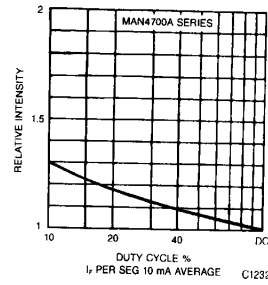

Fig. 14. Luminous Intensity vs. Duty Cycle

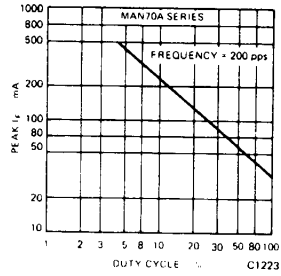

Fig. 15. Max Peak Current vs. Duty Cycle

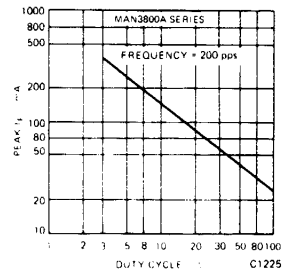

Fig. 16. Max Peak Current vs. Duty Cycle

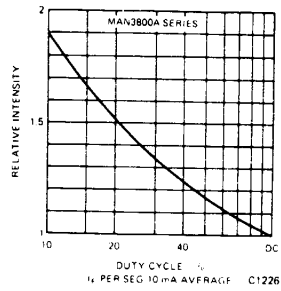

Fig. 17. Luminous Intensity vs. Duty Cycle

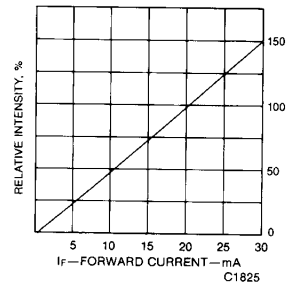

Fig. 18. Relative Luminous Intensity vs. Forward Current