

## LM340, LM340A and LM7805 Family Wide $V_{IN}$ 1.5-A Fixed Voltage Regulators

### 1 Features

- Output Current up to 1.5 A
- Available in Fixed 5-V, 12-V, and 15-V Options
- Output Voltage Tolerances of  $\pm 2\%$  at  $T_J = 25^\circ\text{C}$  (LM340A)
- Line Regulation of 0.01% / V of at 1-A Load (LM340A)
- Load Regulation of 0.3% / A (LM340A)
- Internal Thermal Overload, Short-Circuit and SOA Protection
- Available in Space-Saving SOT-223 Package
- Output Capacitance Not Required for Stability

### 2 Applications

- Industrial Power Supplies
- SMPS Post Regulation
- HVAC Systems
- AC Invertors
- Test and Measurement Equipment
- Brushed and Brushless DC Motor Drivers
- Solar Energy String Invertors

#### Available Packages

Pin 1. Input  
2. Ground  
3. Output  
Tab/Case is Ground or Output

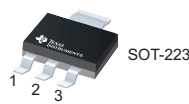
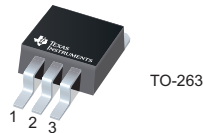
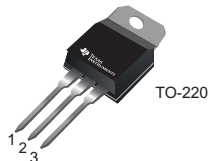
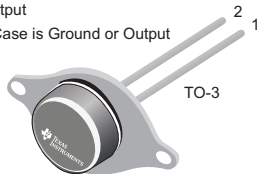

### 3 Description

The LM340 and LM7805 Family monolithic 3-terminal positive voltage regulators employ internal current-limiting, thermal shutdown and safe-area compensation, making them essentially indestructible. If adequate heat sinking is provided, they can deliver over 1.5-A output current. They are intended as fixed voltage regulators in a wide range of applications including local (on-card) regulation for elimination of noise and distribution problems associated with single-point regulation. In addition to use as fixed voltage regulators, these devices can be used with external components to obtain adjustable output voltages and currents.

Considerable effort was expended to make the entire series of regulators easy to use and minimize the number of external components. It is not necessary to bypass the output, although this does improve transient response. Input bypassing is needed only if the regulator is located far from the filter capacitor of the power supply.

LM7805 is also available in a higher accuracy and better performance version (LM340A). Refer to LM340A specifications in the [LM340A Electrical Characteristics](#) table.

#### Device Information<sup>(1)</sup>

PART NUMBER	PACKAGE	BODY SIZE (NOM)
LM340x LM7805 Family	DDPAK/TO-263 (3)	10.18 mm x 8.41 mm
	SOT-23 (4)	6.50 mm x 3.50 mm
	TO-220 (3)	14.986 mm x 10.16 mm
	TO-3 (2)	38.94 mm x 25.40 mm

(1) For all available packages, see the orderable addendum at the end of the data sheet.

#### Fixed Output Voltage Regulator

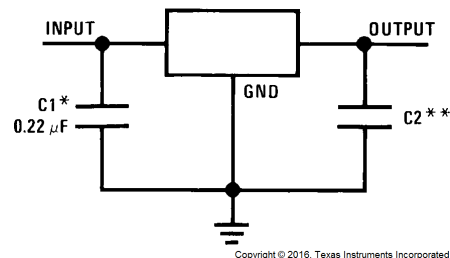

\*Required if the regulator is located far from the power supply filter.

\*\*Although no output capacitor is needed for stability, it does help transient response. (If needed, use 0.1- $\mu\text{F}$ , ceramic disc).



## Table of Contents

<b>1 Features</b> .....	<b>1</b>	7.3 Feature Description .....	<b>12</b>
<b>2 Applications</b> .....	<b>1</b>	7.4 Device Functional Modes .....	<b>12</b>
<b>3 Description</b> .....	<b>1</b>	<b>8 Application and Implementation</b> .....	<b>13</b>
<b>4 Revision History</b> .....	<b>2</b>	8.1 Application Information .....	<b>13</b>
<b>5 Pin Configuration and Functions</b> .....	<b>3</b>	8.2 Typical Applications .....	<b>14</b>
<b>6 Specifications</b> .....	<b>4</b>	8.3 System Examples .....	<b>15</b>
6.1 Absolute Maximum Ratings .....	<b>4</b>	<b>9 Power Supply Recommendations</b> .....	<b>17</b>
6.2 ESD Ratings .....	<b>4</b>	<b>10 Layout</b> .....	<b>17</b>
6.3 Recommended Operating Conditions .....	<b>4</b>	10.1 Layout Guidelines .....	<b>17</b>
6.4 Thermal Information .....	<b>4</b>	10.2 Layout Example .....	<b>17</b>
6.5 LM340A Electrical Characteristics, V <sub>O</sub> = 5 V, V <sub>I</sub> = 10 V .....	<b>5</b>	10.3 Heat Sinking DDPAK/TO-263 and SOT-223 Package Parts .....	<b>18</b>
6.6 LM340 / LM7805 Electrical Characteristics, V <sub>O</sub> = 5 V, V <sub>I</sub> = 10 V .....	<b>6</b>	<b>11 Device and Documentation Support</b> .....	<b>20</b>
6.7 LM340 / LM7812 Electrical Characteristics, V <sub>O</sub> = 12 V, V <sub>I</sub> = 19 V .....	<b>7</b>	11.1 Documentation Support .....	<b>20</b>
6.8 LM340 / LM7815 Electrical Characteristics, V <sub>O</sub> = 15 V, V <sub>I</sub> = 23 V .....	<b>8</b>	11.2 Related Links .....	<b>20</b>
6.9 Typical Characteristics .....	<b>9</b>	11.3 Receiving Notification of Documentation Updates .....	<b>20</b>
<b>7 Detailed Description</b> .....	<b>12</b>	11.4 Community Resources .....	<b>20</b>
7.1 Overview .....	<b>12</b>	11.5 Trademarks .....	<b>20</b>
7.2 Functional Block Diagram .....	<b>12</b>	11.6 Electrostatic Discharge Caution .....	<b>20</b>
		11.7 Glossary .....	<b>20</b>
		<b>12 Mechanical, Packaging, and Orderable Information</b> .....	<b>21</b>

## 4 Revision History

NOTE: Page numbers for previous revisions may differ from page numbers in the current version.

### Changes from Revision K (November 2015) to Revision L Page

- Changed pinout number order for the TO-220 and SOT-223 packages from: 2, 3, 1 to: 1, 2, 3 ..... **1**

### Changes from Revision J (December 2013) to Revision K Page

- Added *ESD Ratings* table, *Thermal Information* table, *Feature Description* section, *Device Functional Modes*, *Application and Implementation* section, *Power Supply Recommendations* section, *Layout* section, *Device and Documentation Support* section, and *Mechanical, Packaging, and Orderable Information* section..... **1**
- Deleted obsolete LM140 and LM7808C devices from the data sheet ..... **1**
- Changed [Figure 13](#) caption from *Line Regulation 140AK-5.0* to *Line Regulation LM340*, ..... **11**
- Changed [Figure 14](#) caption from *Line Regulation 140AK-5.0* to *Line Regulation LM340*, ..... **11**

### Changes from Revision I (March 2013) to Revision J Page

- Changed 0.5 from typ to max ..... **5**

## 5 Pin Configuration and Functions

**LM7805 and LM7812 KTT Package  
3-Pin DPAK/TO-263  
Top View**

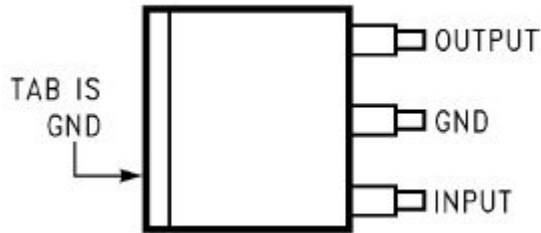

**LM7805 DCY Package  
4-Pin SOT-223  
Side View**

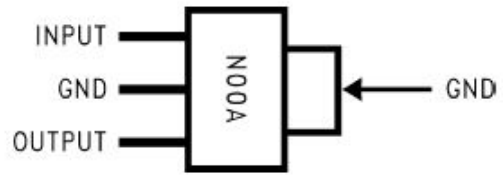

**LM7805, LM7812, and LM7815 NDE Package  
3-Pin TO-220  
Top View**

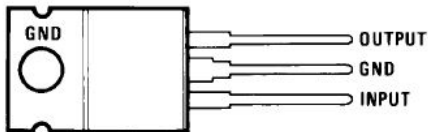

**LM340K-5.0 NDS Package  
2-Pin TO-3  
Top View**

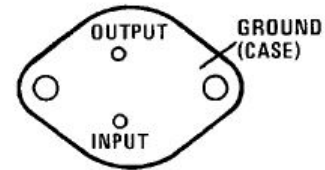

### Pin Functions

PIN		I/O	DESCRIPTION
NAME	NO.		
INPUT	1	I	Input voltage pin
GND	2	I/O	Ground pin
OUTPUT	3	O	Output voltage pin

## 6 Specifications

### 6.1 Absolute Maximum Ratings

 over operating free-air temperature range (unless otherwise noted)<sup>(1)(2)</sup>

	MIN	MAX	UNIT
DC input voltage		35	V
Internal power dissipation <sup>(3)</sup>	Internally Limited		
Maximum junction temperature		150	°C
Lead temperature (soldering, 10 sec.)	TO-3 package (NDS)	300	°C
	Lead temperature 1,6 mm (1/16 in) from case for 10 s	230	°C
Storage temperature	-65	150	°C

- Stresses beyond those listed under *Absolute Maximum Ratings* may cause permanent damage to the device. These are stress ratings only, which do not imply functional operation of the device at these or any other conditions beyond those indicated under *Recommended Operating Conditions*. Exposure to absolute-maximum-rated conditions for extended periods may affect device reliability.
- If Military/Aerospace specified devices are required, please contact the Texas Instruments Sales Office/Distributors for availability and specifications.
- The maximum allowable power dissipation at any ambient temperature is a function of the maximum junction temperature for operation ( $T_{JMAX} = 125^{\circ}\text{C}$  or  $150^{\circ}\text{C}$ ), the junction-to-ambient thermal resistance ( $\theta_{JA}$ ), and the ambient temperature ( $T_A$ ).  $P_{DMAX} = (T_{JMAX} - T_A)/\theta_{JA}$ . If this dissipation is exceeded, the die temperature rises above  $T_{JMAX}$  and the electrical specifications do not apply. If the die temperature rises above  $150^{\circ}\text{C}$ , the device goes into thermal shutdown. For the TO-3 package (NDS), the junction-to-ambient thermal resistance ( $\theta_{JA}$ ) is  $39^{\circ}\text{C/W}$ . When using a heat sink,  $\theta_{JA}$  is the sum of the  $4^{\circ}\text{C/W}$  junction-to-case thermal resistance ( $\theta_{JC}$ ) of the TO-3 package and the case-to-ambient thermal resistance of the heat sink. For the TO-220 package (NDE),  $\theta_{JA}$  is  $54^{\circ}\text{C/W}$  and  $\theta_{JC}$  is  $4^{\circ}\text{C/W}$ . If SOT-223 is used, the junction-to-ambient thermal resistance is  $174^{\circ}\text{C/W}$  and can be reduced by a heat sink (see Applications Hints on heat sinking). If the DDPAK\TO-263 package is used, the thermal resistance can be reduced by increasing the PCB copper area thermally connected to the package: Using 0.5 square inches of copper area,  $\theta_{JA}$  is  $50^{\circ}\text{C/W}$ ; with 1 square inch of copper area,  $\theta_{JA}$  is  $37^{\circ}\text{C/W}$ ; and with 1.6 or more inches of copper area,  $\theta_{JA}$  is  $32^{\circ}\text{C/W}$ .

### 6.2 ESD Ratings

	VALUE	UNIT
$V_{(ESD)}$ Electrostatic discharge Human-body model (HBM) <sup>(1)</sup>	$\pm 2000$	V

- ESD rating is based on the human-body model, 100 pF discharged through 1.5 k $\Omega$ .

### 6.3 Recommended Operating Conditions

over operating free-air temperature range (unless otherwise noted)

	MIN	MAX	UNIT
Temperature ( $T_A$ ) LM340A, LM340	0	125	°C

### 6.4 Thermal Information

THERMAL METRIC <sup>(1)</sup>	LM340, LM7805 Family				UNIT
	NDE (TO-220)	KTT (DDPAK\TO-263)	DCY (SOT-223)	NDS (TO-3)	
	3 PINS	3 PINS	4 PINS	2 PINS	
$R_{\theta JA}$ Junction-to-ambient thermal resistance	23.9	44.8	62.1	39	°C/W
$R_{\theta JC(top)}$ Junction-to-case (top) thermal resistance	16.7	45.6	44	2	°C/W
$R_{\theta JB}$ Junction-to-board thermal resistance	5.3	24.4	10.7	—	°C/W
$\psi_{JT}$ Junction-to-top characterization parameter	3.2	11.2	2.7	—	°C/W
$\psi_{JB}$ Junction-to-board characterization parameter	5.3	23.4	10.6	—	°C/W
$R_{\theta JC(bot)}$ Junction-to-case (bottom) thermal resistance	1.7	1.5	—	—	°C/W

- For more information about traditional and new thermal metrics, see the [Semiconductor and IC Package Thermal Metrics](#) application report.

## 6.5 LM340A Electrical Characteristics,

$V_O = 5\text{ V}$ ,  $V_I = 10\text{ V}$

$I_{OUT} = 1\text{ A}$ ,  $0^\circ\text{C} \leq T_J \leq 125^\circ\text{C}$  (LM340A) unless otherwise specified<sup>(1)</sup>

PARAMETER		TEST CONDITIONS	MIN	TYP	MAX	UNIT	
$V_O$	Output voltage	$T_J = 25^\circ\text{C}$	4.9	5	5.1	V	
		$P_D \leq 15\text{ W}$ , $5\text{ mA} \leq I_O \leq 1\text{ A}$ $7.5\text{ V} \leq V_{IN} \leq 20\text{ V}$	4.8		5.2	V	
$\Delta V_O$	Line regulation	$7.5\text{ V} \leq V_{IN} \leq 20\text{ V}$	$T_J = 25^\circ\text{C}$	3	10	mV	
			Over temperature, $I_O = 500\text{ mA}$			10	mV
		$8\text{ V} \leq V_{IN} \leq 12\text{ V}$	$T_J = 25^\circ\text{C}$			4	mV
			Over temperature			12	mV
$\Delta V_O$	Load regulation	$T_J = 25^\circ\text{C}$	$5\text{ mA} \leq I_O \leq 1.5\text{ A}$	10	25	mV	
			$250\text{ mA} \leq I_O \leq 750\text{ mA}$			15	mV
		Over temperature, $5\text{ mA} \leq I_O \leq 1\text{ A}$			25	mV	
$I_Q$	Quiescent current	$T_J = 25^\circ\text{C}$			6	mA	
		Over temperature			6.5	mA	
$\Delta I_Q$	Quiescent current change	$T_J = 25^\circ\text{C}$ , $I_O = 1\text{ A}$ $7.5\text{ V} \leq V_{IN} \leq 20\text{ V}$			0.8	mA	
			Over temperature, $5\text{ mA} \leq I_O \leq 1\text{ A}$			0.5	mA
		Over temperature, $I_O = 500\text{ mA}$ $8\text{ V} \leq V_{IN} \leq 25\text{ V}$			0.8	mA	
$V_N$	Output noise voltage	$T_A = 25^\circ\text{C}$ , $10\text{ Hz} \leq f \leq 100\text{ kHz}$		40		$\mu\text{V}$	
$\frac{\Delta V_{IN}}{\Delta V_{OUT}}$	Ripple rejection	$f = 120\text{ Hz}$ $8\text{ V} \leq V_{IN} \leq 18\text{ V}$	$T_J = 25^\circ\text{C}$ , $I_O = 1\text{ A}$	68	80	dB	
			Over temperature, $I_O = 500\text{ mA}$	68		dB	
$R_O$	Dropout voltage	$T_J = 25^\circ\text{C}$ , $I_O = 1\text{ A}$		2		V	
	Output resistance	$f = 1\text{ kHz}$		8		$\text{m}\Omega$	
	Short-circuit current	$T_J = 25^\circ\text{C}$		2.1		A	
	Peak output current	$T_J = 25^\circ\text{C}$		2.4		A	
	Average TC of $V_O$	Min, $T_J = 0^\circ\text{C}$ , $I_O = 5\text{ mA}$			-0.6		$\text{mV}/^\circ\text{C}$
$V_{IN}$	Input voltage required to maintain line regulation	$T_J = 25^\circ\text{C}$	7.5			V	

- (1) All characteristics are measured with a  $0.22\text{-}\mu\text{F}$  capacitor from input to ground and a  $0.1\text{-}\mu\text{F}$  capacitor from output to ground. All characteristics except noise voltage and ripple rejection ratio are measured using pulse techniques ( $t_w \leq 10\text{ ms}$ , duty cycle  $\leq 5\%$ ). Output voltage changes due to changes in internal temperature must be taken into account separately.

## 6.6 LM340 / LM7805 Electrical Characteristics,

 **$V_O = 5\text{ V}$ ,  $V_I = 10\text{ V}$** 
 $0^\circ\text{C} \leq T_J \leq 125^\circ\text{C}$  unless otherwise specified<sup>(1)</sup>

PARAMETER		TEST CONDITIONS	MIN	TYP	MAX	UNIT
$V_O$	Output voltage	$T_J = 25^\circ\text{C}$ , $5\text{ mA} \leq I_O \leq 1\text{ A}$	4.8	5	5.2	V
		$P_D \leq 15\text{ W}$ , $5\text{ mA} \leq I_O \leq 1\text{ A}$ $7.5\text{ V} \leq V_{IN} \leq 20\text{ V}$	4.75		5.25	V
$\Delta V_O$	Line regulation	$I_O = 500\text{ mA}$	$T_J = 25^\circ\text{C}$ $7\text{ V} \leq V_{IN} \leq 25\text{ V}$	3	50	mV
			Over temperature $8\text{ V} \leq V_{IN} \leq 20\text{ V}$		50	mV
		$I_O \leq 1\text{ A}$	$T_J = 25^\circ\text{C}$ $7.5\text{ V} \leq V_{IN} \leq 20\text{ V}$		50	mV
			Over temperature $8\text{ V} \leq V_{IN} \leq 12\text{ V}$		25	mV
$\Delta V_O$	Load regulation	$T_J = 25^\circ\text{C}$	$5\text{ mA} \leq I_O \leq 1.5\text{ A}$	10	50	mV
			$250\text{ mA} \leq I_O \leq 750\text{ mA}$		25	mV
		Over temperature, $5\text{ mA} \leq I_O \leq 1\text{ A}$		50	mV	
$I_Q$	Quiescent current	$I_O \leq 1\text{ A}$	$T_J = 25^\circ\text{C}$		8	mA
			Over temperature		8.5	mA
$\Delta I_Q$	Quiescent current change	$0^\circ\text{C} \leq T_J \leq 125^\circ\text{C}$ , $5\text{ mA} \leq I_O \leq 1\text{ A}$ $7\text{ V} \leq V_{IN} \leq 20\text{ V}$	$T_J = 25^\circ\text{C}$ , $I_O \leq 1\text{ A}$	0.5		mA
			Over temperature, $I_O \leq 500\text{ mA}$		1	mA
			Over temperature, $I_O \leq 500\text{ mA}$		1	mA
$V_N$	Output noise voltage	$T_A = 25^\circ\text{C}$ , $10\text{ Hz} \leq f \leq 100\text{ kHz}$		40		$\mu\text{V}$
$\frac{\Delta V_{IN}}{\Delta V_{OUT}}$	Ripple rejection	$f = 120\text{ Hz}$ $8\text{ V} \leq V_{IN} \leq 18\text{ V}$	$T_J = 25^\circ\text{C}$ , $I_O \leq 1\text{ A}$	62	80	dB
			Over temperature, $I_O \leq 500\text{ mA}$	62		dB
$R_O$	Dropout voltage	$T_J = 25^\circ\text{C}$ , $I_O = 1\text{ A}$		2		V
	Output resistance	$f = 1\text{ kHz}$		8		$\text{m}\Omega$
	Short-circuit current	$T_J = 25^\circ\text{C}$		2.1		A
	Peak output current	$T_J = 25^\circ\text{C}$		2.4		A
	Average TC of $V_{OUT}$	Over temperature, $I_O = 5\text{ mA}$		-0.6		$\text{mV}/^\circ\text{C}$
$V_{IN}$	Input voltage required to maintain line regulation	$T_J = 25^\circ\text{C}$ , $I_O \leq 1\text{ A}$	7.5			V

(1) All characteristics are measured with a 0.22- $\mu\text{F}$  capacitor from input to ground and a 0.1- $\mu\text{F}$  capacitor from output to ground. All characteristics except noise voltage and ripple rejection ratio are measured using pulse techniques ( $t_w \leq 10\text{ ms}$ , duty cycle  $\leq 5\%$ ). Output voltage changes due to changes in internal temperature must be taken into account separately.

## 6.7 LM340 / LM7812 Electrical Characteristics,

 $V_O = 12\text{ V}, V_I = 19\text{ V}$ 
 $0^\circ\text{C} \leq T_J \leq 125^\circ\text{C}$  unless otherwise specified<sup>(1)</sup>

PARAMETER		TEST CONDITIONS	MIN	TYP	MAX	UNIT
$V_O$	Output voltage	$T_J = 25^\circ\text{C}, 5\text{ mA} \leq I_O \leq 1\text{ A}$	11.5	12	12.5	V
		$P_D \leq 15\text{ W}, 5\text{ mA} \leq I_O \leq 1\text{ A}$ $14.5\text{ V} \leq V_{IN} \leq 27\text{ V}$	11.4		12.6	V
$\Delta V_O$	Line regulation	$I_O = 500\text{ mA}$	$T_J = 25^\circ\text{C}$ $14.5\text{ V} \leq V_{IN} \leq 30\text{ V}$	4	120	mV
			Over temperature $15\text{ V} \leq V_{IN} \leq 27\text{ V}$		120	mV
		$I_O \leq 1\text{ A}$	$T_J = 25^\circ\text{C}$ $14.6\text{ V} \leq V_{IN} \leq 27\text{ V}$		120	mV
			Over temperature $16\text{ V} \leq V_{IN} \leq 22\text{ V}$		60	mV
$\Delta V_O$	Load regulation	$T_J = 25^\circ\text{C}$	$5\text{ mA} \leq I_O \leq 1.5\text{ A}$	12	120	mV
			$250\text{ mA} \leq I_O \leq 750\text{ mA}$		60	mV
		Over temperature, $5\text{ mA} \leq I_O \leq 1\text{ A}$		120	mV	
$I_Q$	Quiescent current	$I_O \leq 1\text{ A}$	$T_J = 25^\circ\text{C}$		8	mA
			Over temperature		8.5	mA
$\Delta I_Q$	Quiescent current change	$5\text{ mA} \leq I_O \leq 1\text{ A}$		0.5		mA
		$T_J = 25^\circ\text{C}, I_O \leq 1\text{ A}$ $14.8\text{ V} \leq V_{IN} \leq 27\text{ V}$			1	mA
		Over temperature, $I_O \leq 500\text{ mA}$ $14.5\text{ V} \leq V_{IN} \leq 30\text{ V}$			1	mA
$V_N$	Output noise voltage	$T_A = 25^\circ\text{C}, 10\text{ Hz} \leq f \leq 100\text{ kHz}$		75		$\mu\text{V}$
$\frac{\Delta V_{IN}}{\Delta V_{OUT}}$	Ripple rejection	$f = 120\text{ Hz}$	$T_J = 25^\circ\text{C}, I_O \leq 1\text{ A}$	55	72	dB
		$15\text{ V} \leq V_{IN} \leq 25\text{ V}$	Over temperature, $I_O \leq 500\text{ mA}$ ,	55		dB
$R_O$	Dropout voltage	$T_J = 25^\circ\text{C}, I_O = 1\text{ A}$		2		V
	Output resistance	$f = 1\text{ kHz}$		18		$\text{m}\Omega$
	Short-circuit current	$T_J = 25^\circ\text{C}$		1.5		A
	Peak output current	$T_J = 25^\circ\text{C}$		2.4		A
	Average TC of $V_{OUT}$	Over temperature, $I_O = 5\text{ mA}$		-1.5		$\text{mV}/^\circ\text{C}$
$V_{IN}$	Input voltage required to maintain line regulation	$T_J = 25^\circ\text{C}, I_O \leq 1\text{ A}$	14.6			V

- (1) All characteristics are measured with a 0.22- $\mu\text{F}$  capacitor from input to ground and a 0.1- $\mu\text{F}$  capacitor from output to ground. All characteristics except noise voltage and ripple rejection ratio are measured using pulse techniques ( $t_w \leq 10\text{ ms}$ , duty cycle  $\leq 5\%$ ). Output voltage changes due to changes in internal temperature must be taken into account separately.

## 6.8 LM340 / LM7815 Electrical Characteristics,

 **$V_O = 15\text{ V}$ ,  $V_I = 23\text{ V}$** 
 $0^\circ\text{C} \leq T_J \leq 125^\circ\text{C}$  unless otherwise specified<sup>(1)</sup>

PARAMETER		TEST CONDITIONS	MIN	TYP	MAX	UNIT
$V_O$	Output voltage	$T_J = 25^\circ\text{C}$ , $5\text{ mA} \leq I_O \leq 1\text{ A}$	14.4	15	15.6	V
		$P_D \leq 15\text{ W}$ , $5\text{ mA} \leq I_O \leq 1\text{ A}$ $17.5\text{ V} \leq V_{IN} \leq 30\text{ V}$	14.25		15.75	V
$\Delta V_O$	Line regulation	$I_O = 500\text{ mA}$	$T_J = 25^\circ\text{C}$ $17.5\text{ V} \leq V_{IN} \leq 30\text{ V}$	4	150	mV
			Over temperature $18.5\text{ V} \leq V_{IN} \leq 30\text{ V}$		150	mV
		$I_O \leq 1\text{ A}$	$T_J = 25^\circ\text{C}$ $17.7\text{ V} \leq V_{IN} \leq 30\text{ V}$		150	mV
			Over temperature $20\text{ V} \leq V_{IN} \leq 26\text{ V}$		75	mV
$\Delta V_O$	Load regulation	$T_J = 25^\circ\text{C}$	$5\text{ mA} \leq I_O \leq 1.5\text{ A}$	12	150	mV
			$250\text{ mA} \leq I_O \leq 750\text{ mA}$		75	mV
		Over temperature, $5\text{ mA} \leq I_O \leq 1\text{ A}$ ,		150	mV	
$I_Q$	Quiescent current	$I_O \leq 1\text{ A}$	$T_J = 25^\circ\text{C}$		8	mA
			Over temperature		8.5	mA
$\Delta I_Q$	Quiescent current change	$5\text{ mA} \leq I_O \leq 1\text{ A}$		0.5		mA
		$T_J = 25^\circ\text{C}$ , $I_O \leq 1\text{ A}$ $17.9\text{ V} \leq V_{IN} \leq 30\text{ V}$			1	mA
		Over temperature, $I_O \leq 500\text{ mA}$ $17.5\text{ V} \leq V_{IN} \leq 30\text{ V}$			1	mA
$V_N$	Output noise voltage	$T_A = 25^\circ\text{C}$ , $10\text{ Hz} \leq f \leq 100\text{ kHz}$		90		$\mu\text{V}$
$\frac{\Delta V_{IN}}{\Delta V_{OUT}}$	Ripple rejection	$f = 120\text{ Hz}$	$T_J = 25^\circ\text{C}$ , $I_O \leq 1\text{ A}$	54	70	dB
		$18.5\text{ V} \leq V_{IN} \leq 28.5\text{ V}$	Over temperature, $I_O \leq 500\text{ mA}$ ,	54		dB
$R_O$	Dropout voltage	$T_J = 25^\circ\text{C}$ , $I_O = 1\text{ A}$		2		V
	Output resistance	$f = 1\text{ kHz}$		19		$\text{m}\Omega$
	Short-circuit current	$T_J = 25^\circ\text{C}$		1.2		A
	Peak output current	$T_J = 25^\circ\text{C}$		2.4		A
	Average TC of $V_{OUT}$	Over temperature, $I_O = 5\text{ mA}$		-1.8		$\text{mV}/^\circ\text{C}$
$V_{IN}$	Input voltage required to maintain line regulation	$T_J = 25^\circ\text{C}$ , $I_O \leq 1\text{ A}$	17.7			V

- (1) All characteristics are measured with a 0.22- $\mu\text{F}$  capacitor from input to ground and a 0.1- $\mu\text{F}$  capacitor from output to ground. All characteristics except noise voltage and ripple rejection ratio are measured using pulse techniques ( $t_w \leq 10\text{ ms}$ , duty cycle  $\leq 5\%$ ). Output voltage changes due to changes in internal temperature must be taken into account separately.



### 6.9 Typical Characteristics

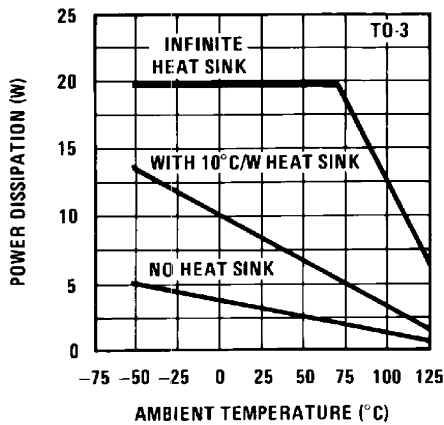

Figure 1. Maximum Average Power Dissipation

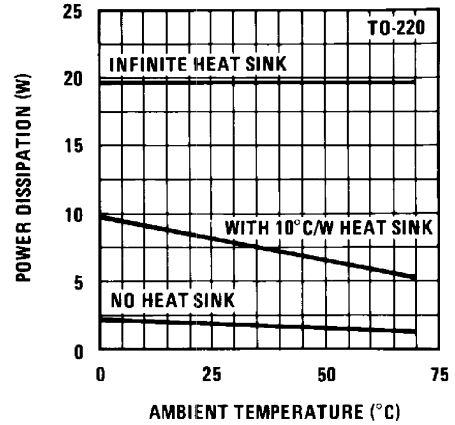

Figure 2. Maximum Average Power Dissipation

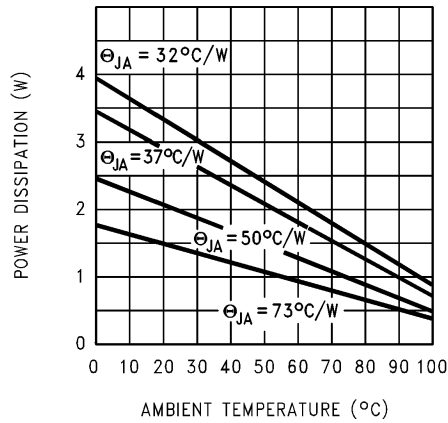
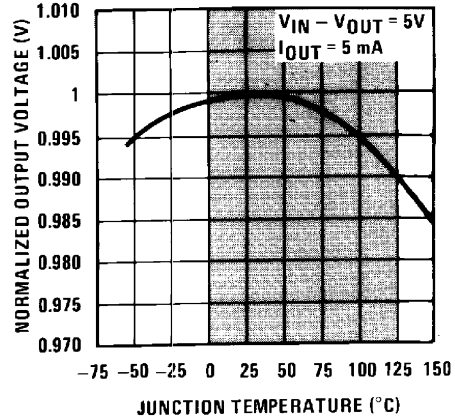

Figure 3. Maximum Power Dissipation (DDPAK/TO-263)



Shaded area refers to LM340A/LM340, LM7805, LM7812 and LM7815.

Figure 4. Output Voltage (Normalized to 1 V at  $T_J = 25^\circ\text{C}$ )

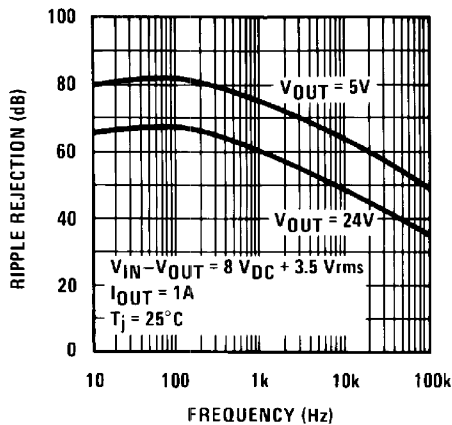

Figure 5. Ripple Rejection

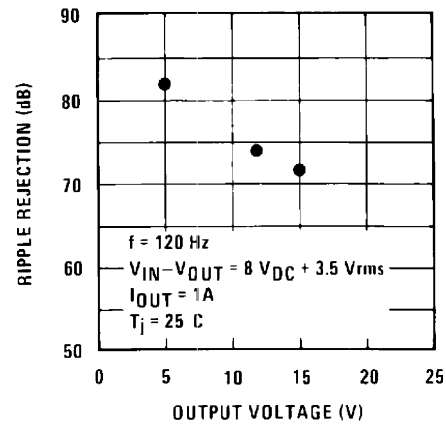

Figure 6. Ripple Rejection

Typical Characteristics (continued)

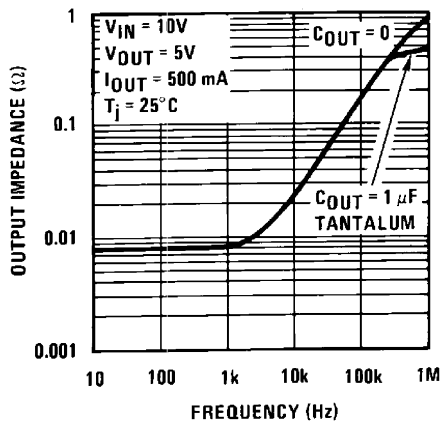

Figure 7. Output Impedance

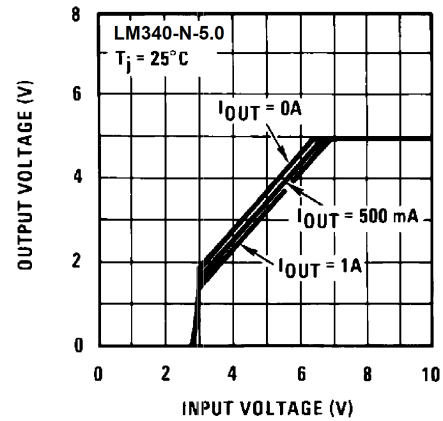
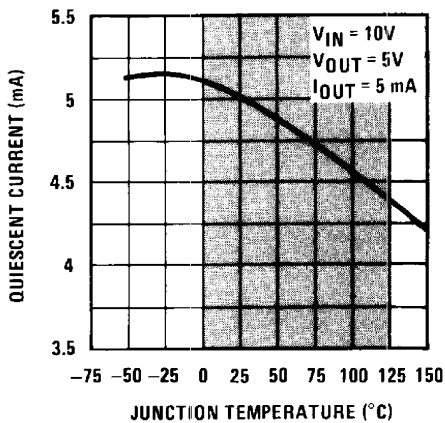

Figure 8. Dropout Characteristics



Shaded area refers to LM340A/LM340, LM7805, LM7812, and LM7815.

Figure 9. Quiescent Current

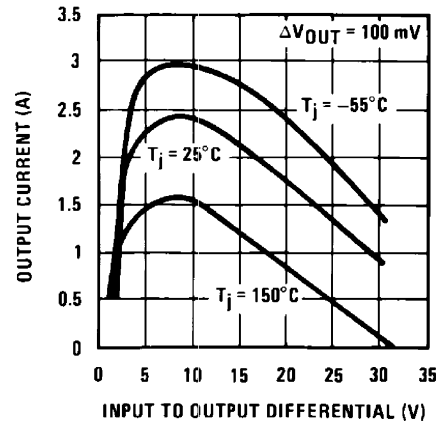
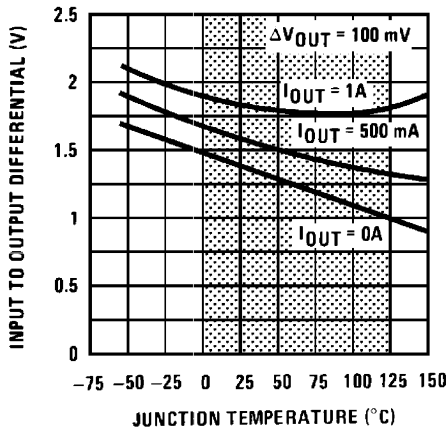

Figure 10. Peak Output Current



Shaded area refers to LM340A/LM340, LM7805, LM7812, and LM7815.

Figure 11. Dropout Voltage

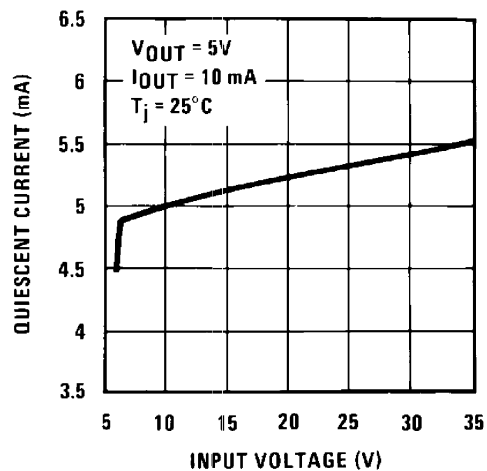
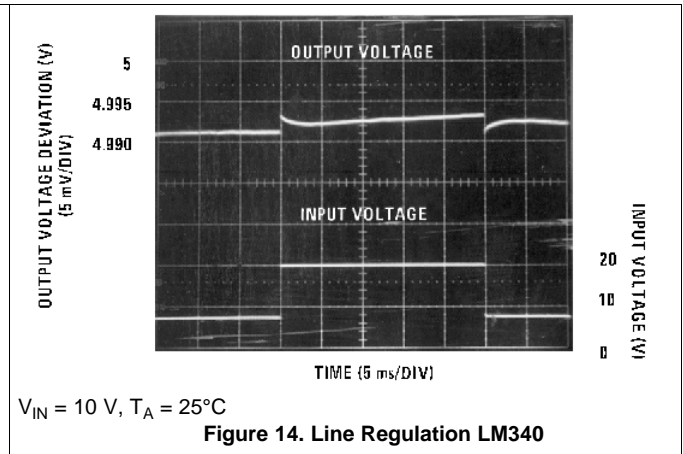
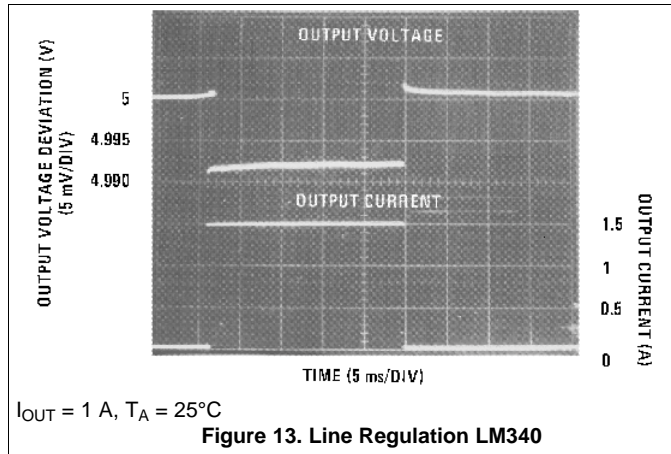

Figure 12. Quiescent Current

**Typical Characteristics (continued)**



## 7 Detailed Description

### 7.1 Overview

The LM340 and LM7805 devices are a family of fixed output positive voltage regulators with outputs ranging from 3 V to 15 V. They accept up to 35 V of input voltage and with proper heat dissipation can provide over 1.5 A of current. With a combination of current limiting, thermal shutdown, and safe area protection, these regulators eliminate any concern of damage. These features paired with excellent line and load regulation make the LM340 and LM7805 Family versatile solutions to a wide range of power management designs. Although the LM340 and LM7805 Family were designed primarily as fixed-voltage regulators, these devices can be used with external component for adjustable voltage and current.

### 7.2 Functional Block Diagram

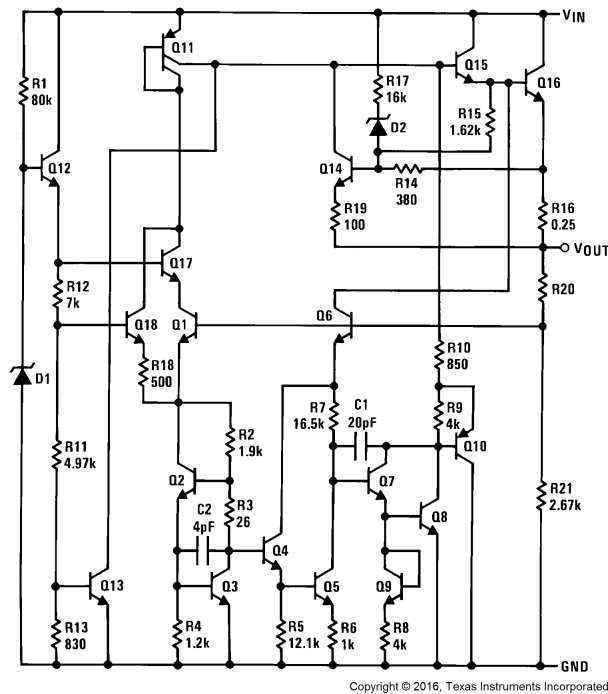

### 7.3 Feature Description

#### 7.3.1 Output Current

With proper considerations, the LM340 and LM7805 Family can exceed 1.5-A output current. Depending on the desired package option, the effective junction-to-ambient thermal resistance can be reduced through heat sinking, allowing more power to be dissipated in the device.

#### 7.3.2 Current Limiting Feature

In the event of a short circuit at the output of the regulator, each device has an internal current limit to protect it from damage. The typical current limits for the LM340 and LM7805 Family is 2.4 A.

#### 7.3.3 Thermal Shutdown

Each package type employs internal current limiting and thermal shutdown to provide safe operation area protection. If the junction temperature is allowed to rise to 150°C, the device will go into thermal shutdown.

### 7.4 Device Functional Modes

There are no functional modes for this device.

## 8 Application and Implementation

### NOTE

Information in the following applications sections is not part of the TI component specification, and TI does not warrant its accuracy or completeness. TI's customers are responsible for determining suitability of components for their purposes. Customers should validate and test their design implementation to confirm system functionality.

### 8.1 Application Information

The LM340x and LM7805 series is designed with thermal protection, output short-circuit protection, and output transistor safe area protection. However, as with any IC regulator, it becomes necessary to take precautions to assure that the regulator is not inadvertently damaged. The following describes possible misapplications and methods to prevent damage to the regulator.

#### 8.1.1 Shorting the Regulator Input

When using large capacitors at the output of these regulators, a protection diode connected input to output (Figure 15) may be required if the input is shorted to ground. Without the protection diode, an input short causes the input to rapidly approach ground potential, while the output remains near the initial  $V_{OUT}$  because of the stored charge in the large output capacitor. The capacitor will then discharge through a large internal input to output diode and parasitic transistors. If the energy released by the capacitor is large enough, this diode, low current metal, and the regulator are destroyed. The fast diode in Figure 15 shunts most of the capacitors discharge current around the regulator. Generally no protection diode is required for values of output capacitance  $\leq 10 \mu\text{F}$ .

#### 8.1.2 Raising the Output Voltage Above the Input Voltage

Because the output of the device does not sink current, forcing the output high can cause damage to internal low current paths in a manner similar to that just described in [Shorting the Regulator Input](#).

#### 8.1.3 Regulator Floating Ground

When the ground pin alone becomes disconnected, the output approaches the unregulated input, causing possible damage to other circuits connected to  $V_{OUT}$ . If ground is reconnected with power ON, damage may also occur to the regulator. This fault is most likely to occur when plugging in regulators or modules with on card regulators into powered up sockets. The power must be turned off first, the thermal limit ceases operating, or the ground must be connected first if power must be left on. See [Figure 16](#).

#### 8.1.4 Transient Voltages

If transients exceed the maximum rated input voltage of the device, or reach more than 0.8 V below ground and have sufficient energy, they will damage the regulator. The solution is to use a large input capacitor, a series input breakdown diode, a choke, a transient suppressor or a combination of these.



Figure 15. Input Short

## Application Information (continued)

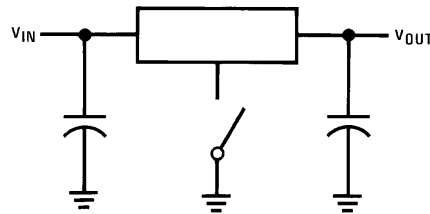

Figure 16. Regulator Floating Ground

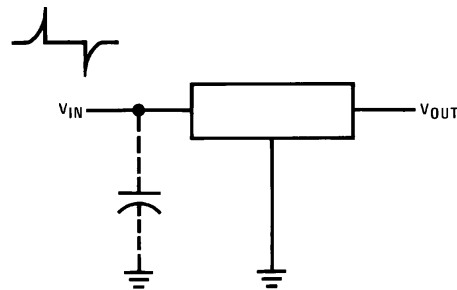

Figure 17. Transients

When a value for  $\theta_{(H-A)}$  is found, a heat sink must be selected that has a value that is less than or equal to this number.

$\theta_{(H-A)}$  is specified numerically by the heat sink manufacturer in this catalog or shown in a curve that plots temperature rise vs power dissipation for the heat sink.

## 8.2 Typical Applications

### 8.2.1 Fixed Output Voltage Regulator

The LM340x and LM7805 Family devices are primarily designed to provide fixed output voltage regulation. The simplest implementation of LM340x and LM7805 Family is shown in Figure 18.

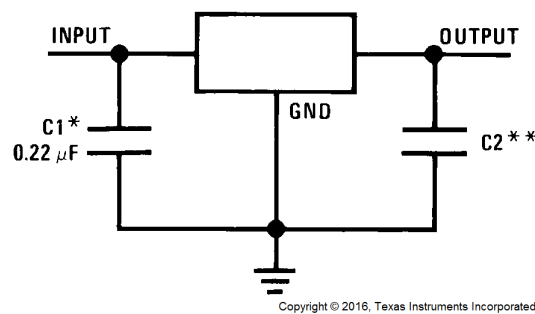

\*Required if the regulator is located far from the power supply filter.

\*\*Although no output capacitor is needed for stability, it does help transient response. (If needed, use 0.1-μF, ceramic disc).

Figure 18. Fixed Output Voltage Regulator

#### 8.2.1.1 Design Requirements

The device component count is very minimal. Although not required, TI recommends employing bypass capacitors at the output for optimum stability and transient response. These capacitors must be placed as close as possible to the regulator. If the device is located more than 6 inches from the power supply filter, it is required to employ input capacitor.

## Typical Applications (continued)

### 8.2.1.2 Detailed Design Procedure

The output voltage is set based on the device variant. LM340x and LM7805 Family are available in 5-V, 12-V and 15-V regulator options.

### 8.2.1.3 Application Curve

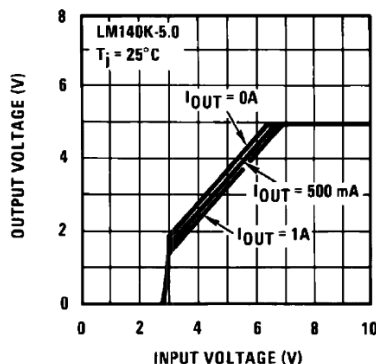
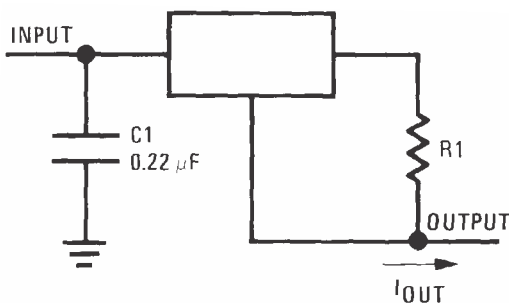

Figure 19.  $V_{OUT}$  vs  $V_{IN}$ ,  $V_{OUT} = 5$  V

## 8.3 System Examples



$$I_{OUT} = V_2 - 3 / R_1 + I_Q$$

$$\Delta I_Q = 1.3 \text{ mA over line and load changes.}$$

Figure 20. Current Regulator

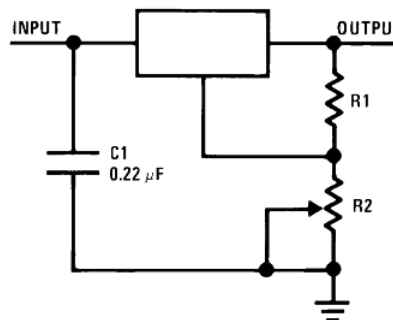

$$V_{OUT} = 5 \text{ V} + (5 \text{ V} / R_1 + I_Q) R_2 \quad 5 \text{ V} / R_1 > 3 I_Q$$

$$\text{load regulation } (L_r) \approx [(R_1 + R_2) / R_1] \quad (L_r \text{ of LM340-5}).$$

Figure 21. Adjustable Output Regulator

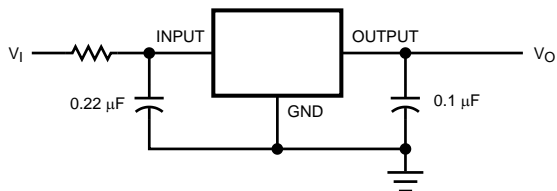

Figure 22. High Input Voltage Circuit With Series Resistor

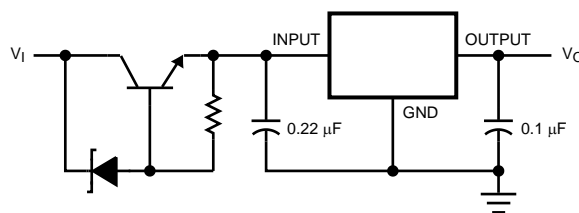
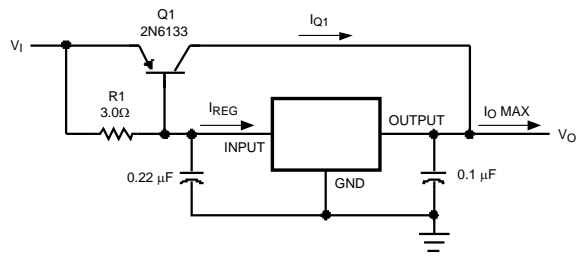

Figure 23. High Input Voltage Circuit implementation With Transistor

System Examples (continued)



$$\beta(Q1) \geq I_{O \text{ Max}} / I_{REG \text{ Max}}$$

$$R1 = 0.9 / I_{REG} = \beta(Q1) V_{BE(Q1)} / I_{REG \text{ Max}} (\beta + 1) - I_{O \text{ Max}}$$

Figure 24. High Current Voltage Regulator

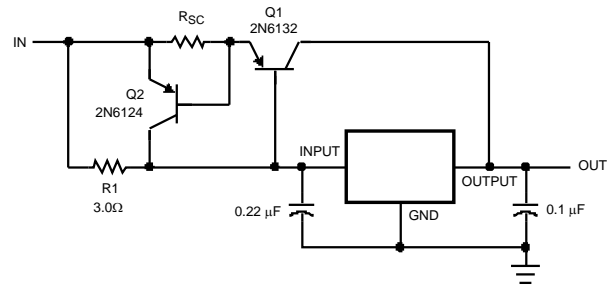

$$R_{SC} = 0.8 / I_{SC}$$

$$R1 = \beta V_{BE(Q1)} / I_{REG \text{ Max}} (\beta + 1) - I_{O \text{ Max}}$$

Figure 25. High Output Current With Short-Circuit Protection

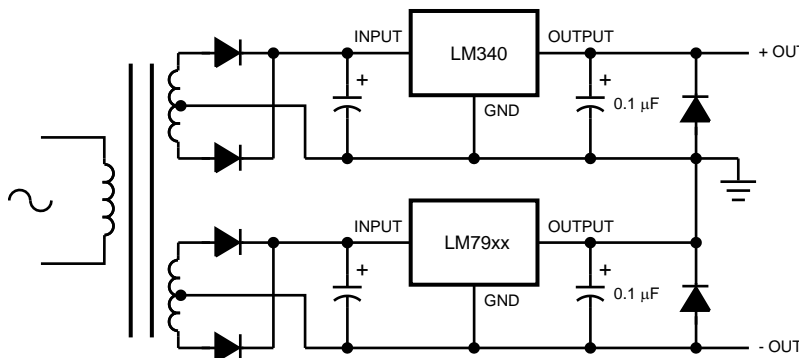

Figure 26. LM340 Used With Negative Regulator LM79xx



## 9 Power Supply Recommendations

The LM340 is designed to operate from a wide input voltage up to 35 V. Please refer to electrical characteristics tables for the minimum input voltage required for line/load regulation. If the device is more than six inches from the input filter capacitors, an input bypass capacitor, 0.1  $\mu\text{F}$  or greater, of any type is needed for stability.

## 10 Layout

### 10.1 Layout Guidelines

Some layout guidelines must be followed to ensure proper regulation of the output voltage with minimum noise. Traces carrying the load current must be wide to reduce the amount of parasitic trace inductance. To improve PSRR, a bypass capacitor can be placed at the OUTPUT pin and must be placed as close as possible to the IC. All that is required for the typical fixed output regulator application circuit is the LM340x/LM7805 Family IC and a 0.22- $\mu\text{F}$  input capacitor if the regulator is placed far from the power supply filter. A 0.1- $\mu\text{F}$  output capacitor is recommended to help with transient response. In cases when VIN shorts to ground, an external diode must be placed from VOUT to VIN to divert the surge current from the output capacitor and protect the IC.

### 10.2 Layout Example

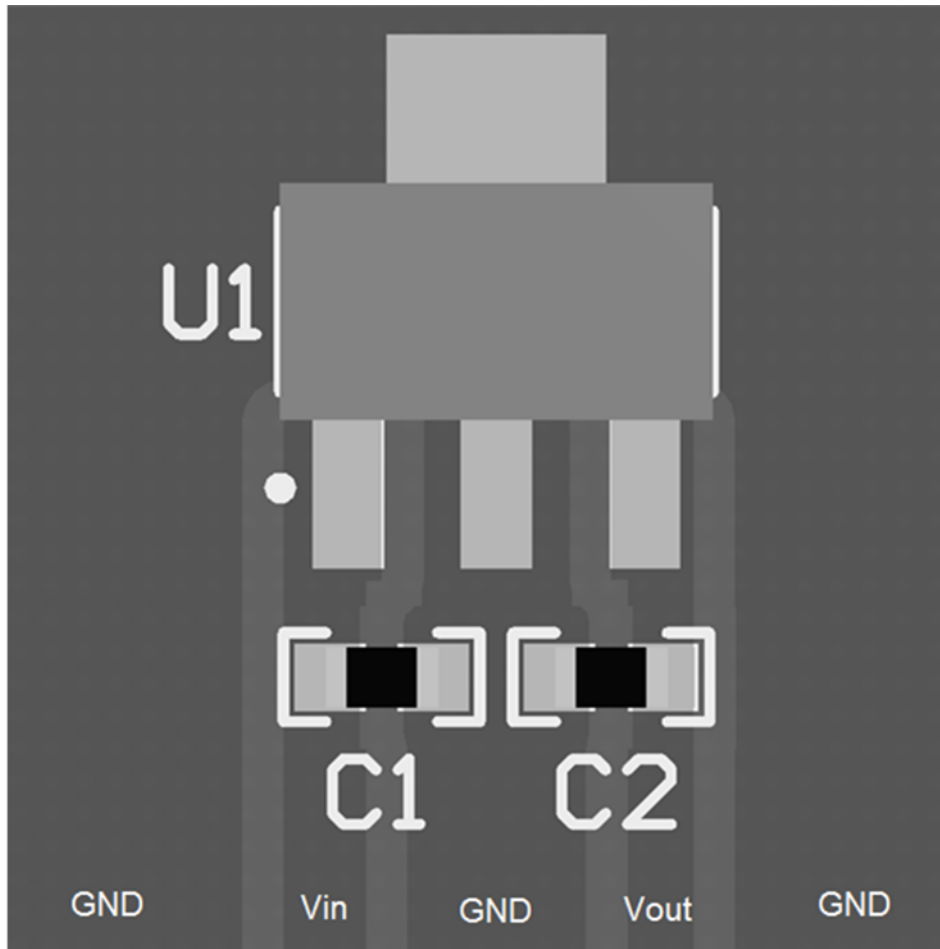
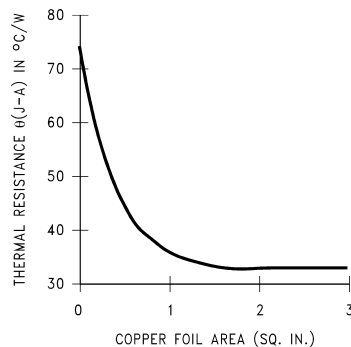

Figure 27. Layout Example DDPAK

**Layout Example (continued)**

**Figure 28. Layout Example SOT-223**
**10.3 Heat Sinking DDPAK/TO-263 and SOT-223 Package Parts**

Both the DDPAK/TO-263 (KTT) and SOT-223 (DCY) packages use a copper plane on the PCB and the PCB itself as a heat sink. To optimize the heat sinking ability of the plane and PCB, solder the tab of the plane.

**Figure 29** shows for the DDPAK/TO-263 the measured values of  $\theta_{(J-A)}$  for different copper area sizes using a typical PCB with 1-oz copper *and no solder mask over the copper area used for heat sinking*.

**Figure 29.  $\theta_{(J-A)}$  vs Copper (1 Ounce) Area for the DDPAK/TO-263 Package**

### Heat Sinking DDPAK/TO-263 and SOT-223 Package Parts (continued)

As shown in Figure 29, increasing the copper area beyond 1 square inch produces very little improvement. It should also be observed that the minimum value of  $\theta_{(J-A)}$  for the DDPAK/TO-263 package mounted to a PCB is 32°C/W.

As a design aid, Figure 30 shows the maximum allowable power dissipation compared to ambient temperature for the DDPAK/TO-263 device (assuming  $\theta_{(J-A)}$  is 35°C/W and the maximum junction temperature is 125°C).

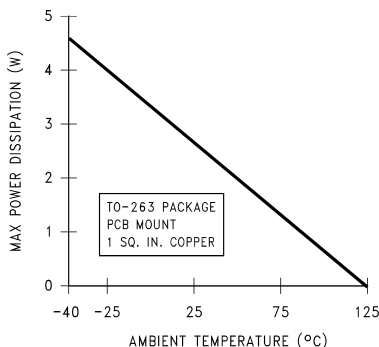
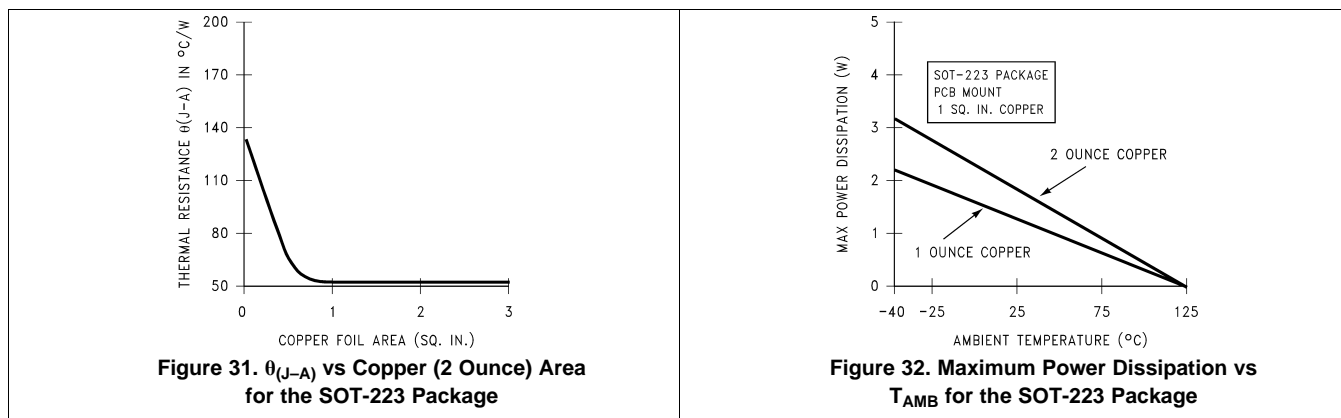

Figure 30. Maximum Power Dissipation vs  $T_{AMB}$  for the DDPAK/TO-263 Package

Figure 31 and Figure 32 show the information for the SOT-223 package. Figure 31 assumes a  $\theta_{(J-A)}$  of 74°C/W for 1-oz. copper and 51°C/W for 2-oz. copper and a maximum junction temperature of 125°C.



See AN-1028 LMX2370 PLLatinum Dual Freq Synth for RF Pers Comm LMX2370 2.5GHz/1.2GHz (SNVA036) for power enhancement techniques to be used with the SOT-223 package.

## 11 Device and Documentation Support

### 11.1 Documentation Support

#### 11.1.1 Related Documentation

For related documentation, see the following:

- [AN-1028 LMX2370 PLLatinum Dual Freq Synth for RF Pers Comm LMX2370 2.5GHz/1.2GHz](#) (SNVA036)
- [LM140K Series 3-Terminal Positive Regulators](#) (SNVS994)

#### 11.2 Related Links

The table below lists quick access links. Categories include technical documents, support and community resources, tools and software, and quick access to sample or buy.

**Table 1. Related Links**

PARTS	PRODUCT FOLDER	SAMPLE & BUY	TECHNICAL DOCUMENTS	TOOLS & SOFTWARE	SUPPORT & COMMUNITY
LM340	<a href="#">Click here</a>	<a href="#">Click here</a>	<a href="#">Click here</a>	<a href="#">Click here</a>	<a href="#">Click here</a>
LM340A	<a href="#">Click here</a>	<a href="#">Click here</a>	<a href="#">Click here</a>	<a href="#">Click here</a>	<a href="#">Click here</a>
LM7805	<a href="#">Click here</a>	<a href="#">Click here</a>	<a href="#">Click here</a>	<a href="#">Click here</a>	<a href="#">Click here</a>
LM7812	<a href="#">Click here</a>	<a href="#">Click here</a>	<a href="#">Click here</a>	<a href="#">Click here</a>	<a href="#">Click here</a>
LM7815	<a href="#">Click here</a>	<a href="#">Click here</a>	<a href="#">Click here</a>	<a href="#">Click here</a>	<a href="#">Click here</a>

#### 11.3 Receiving Notification of Documentation Updates

To receive notification of documentation updates, navigate to the device product folder on ti.com. In the upper right corner, click on *Alert me* to register and receive a weekly digest of any product information that has changed. For change details, review the revision history included in any revised document.

#### 11.4 Community Resources

The following links connect to TI community resources. Linked contents are provided "AS IS" by the respective contributors. They do not constitute TI specifications and do not necessarily reflect TI's views; see TI's [Terms of Use](#).

**TI E2E™ Online Community** *TI's Engineer-to-Engineer (E2E) Community*. Created to foster collaboration among engineers. At [e2e.ti.com](http://e2e.ti.com), you can ask questions, share knowledge, explore ideas and help solve problems with fellow engineers.

**Design Support** *TI's Design Support* Quickly find helpful E2E forums along with design support tools and contact information for technical support.

#### 11.5 Trademarks

E2E is a trademark of Texas Instruments.

All other trademarks are the property of their respective owners.

#### 11.6 Electrostatic Discharge Caution



These devices have limited built-in ESD protection. The leads should be shorted together or the device placed in conductive foam during storage or handling to prevent electrostatic damage to the MOS gates.

#### 11.7 Glossary

**SLYZ022** — *TI Glossary*.

This glossary lists and explains terms, acronyms, and definitions.

## 12 Mechanical, Packaging, and Orderable Information

The following pages include mechanical, packaging, and orderable information. This information is the most current data available for the designated devices. This data is subject to change without notice and revision of this document. For browser-based versions of this data sheet, refer to the left-hand navigation.

**PACKAGING INFORMATION**

Orderable Device	Status (1)	Package Type	Package Drawing	Pins	Package Qty	Eco Plan (2)	Lead/Ball Finish (6)	MSL Peak Temp (3)	Op Temp (°C)	Device Marking (4/5)	Samples
LM340AT-5.0	NRND	TO-220	NDE	3	45	TBD	Call TI	Call TI	0 to 70	LM340AT 5.0 P+	
LM340AT-5.0/NOPB	ACTIVE	TO-220	NDE	3	45	Pb-Free (RoHS Exempt)	CU SN	Level-1-NA-UNLIM	0 to 125	LM340AT 5.0 P+	<a href="#">Samples</a>
LM340K-5.0	ACTIVE	TO-3	NDS	2	50	TBD	Call TI	Call TI	0 to 125	LM340K -5.0 7805P+	<a href="#">Samples</a>
LM340K-5.0/NOPB	ACTIVE	TO-3	NDS	2	50	Green (RoHS & no Sb/Br)	Call TI	Level-1-NA-UNLIM	0 to 125	LM340K -5.0 7805P+	<a href="#">Samples</a>
LM340MP-5.0	NRND	SOT-223	DCY	4	1000	TBD	Call TI	Call TI	0 to 70	N00A	
LM340MP-5.0/NOPB	ACTIVE	SOT-223	DCY	4	1000	Green (RoHS & no Sb/Br)	CU SN	Level-1-260C-UNLIM	0 to 125	N00A	<a href="#">Samples</a>
LM340MPX-5.0/NOPB	ACTIVE	SOT-223	DCY	4	2000	Green (RoHS & no Sb/Br)	CU SN	Level-1-260C-UNLIM	0 to 125	N00A	<a href="#">Samples</a>
LM340S-12/NOPB	ACTIVE	DDPAK/ TO-263	KTT	3	45	Pb-Free (RoHS Exempt)	CU SN	Level-3-245C-168 HR	0 to 125	LM340S -12 P+	<a href="#">Samples</a>
LM340S-5.0	NRND	DDPAK/ TO-263	KTT	3	45	TBD	Call TI	Call TI	0 to 70	LM340S -5.0 P+	
LM340S-5.0/NOPB	ACTIVE	DDPAK/ TO-263	KTT	3	45	Pb-Free (RoHS Exempt)	CU SN	Level-3-245C-168 HR	0 to 125	LM340S -5.0 P+	<a href="#">Samples</a>
LM340SX-12/NOPB	ACTIVE	DDPAK/ TO-263	KTT	3	500	Pb-Free (RoHS Exempt)	CU SN	Level-3-245C-168 HR	0 to 125	LM340S -12 P+	<a href="#">Samples</a>
LM340SX-5.0	NRND	DDPAK/ TO-263	KTT	3	500	TBD	Call TI	Call TI	0 to 70	LM340S -5.0 P+	
LM340SX-5.0/NOPB	ACTIVE	DDPAK/ TO-263	KTT	3	500	Pb-Free (RoHS Exempt)	CU SN	Level-3-245C-168 HR	0 to 125	LM340S -5.0 P+	<a href="#">Samples</a>
LM340T-12	NRND	TO-220	NDE	3	45	TBD	Call TI	Call TI	0 to 70	LM340T12 7812 P+	
LM340T-12/NOPB	ACTIVE	TO-220	NDE	3	45	Green (RoHS & no Sb/Br)	CU SN	Level-1-NA-UNLIM	0 to 125	LM340T12 7812 P+	<a href="#">Samples</a>
LM340T-15	NRND	TO-220	NDE	3	45	TBD	Call TI	Call TI	0 to 70	LM340T15 7815 P+	
LM340T-15/NOPB	ACTIVE	TO-220	NDE	3	45	Green (RoHS & no Sb/Br)	CU SN	Level-1-NA-UNLIM	0 to 125	LM340T15 7815 P+	<a href="#">Samples</a>
LM340T-5.0	NRND	TO-220	NDE	3	45	TBD	Call TI	Call TI	0 to 70	LM340T5	

Orderable Device	Status (1)	Package Type	Package Drawing	Pins	Package Qty	Eco Plan (2)	Lead/Ball Finish (6)	MSL Peak Temp (3)	Op Temp (°C)	Device Marking (4/5)	Samples
										7805 P+	
LM340T-5.0/LF01	ACTIVE	TO-220	NDG	3	45	Pb-Free (RoHS Exempt)	CU SN	Level-4-260C-72 HR	0 to 125	LM340T5 7805 P+	<a href="#">Samples</a>
LM340T-5.0/NOPB	ACTIVE	TO-220	NDE	3	45	Pb-Free (RoHS Exempt)	CU SN	Level-1-NA-UNLIM	0 to 125	LM340T5 7805 P+	<a href="#">Samples</a>

(1) The marketing status values are defined as follows:

**ACTIVE:** Product device recommended for new designs.

**LIFEBUY:** TI has announced that the device will be discontinued, and a lifetime-buy period is in effect.

**NRND:** Not recommended for new designs. Device is in production to support existing customers, but TI does not recommend using this part in a new design.

**PREVIEW:** Device has been announced but is not in production. Samples may or may not be available.

**OBSELETE:** TI has discontinued the production of the device.

(2) Eco Plan - The planned eco-friendly classification: Pb-Free (RoHS), Pb-Free (RoHS Exempt), or Green (RoHS & no Sb/Br) - please check <http://www.ti.com/productcontent> for the latest availability information and additional product content details.

**TBD:** The Pb-Free/Green conversion plan has not been defined.

**Pb-Free (RoHS):** TI's terms "Lead-Free" or "Pb-Free" mean semiconductor products that are compatible with the current RoHS requirements for all 6 substances, including the requirement that lead not exceed 0.1% by weight in homogeneous materials. Where designed to be soldered at high temperatures, TI Pb-Free products are suitable for use in specified lead-free processes.

**Pb-Free (RoHS Exempt):** This component has a RoHS exemption for either 1) lead-based flip-chip solder bumps used between the die and package, or 2) lead-based die adhesive used between the die and leadframe. The component is otherwise considered Pb-Free (RoHS compatible) as defined above.

**Green (RoHS & no Sb/Br):** TI defines "Green" to mean Pb-Free (RoHS compatible), and free of Bromine (Br) and Antimony (Sb) based flame retardants (Br or Sb do not exceed 0.1% by weight in homogeneous material)

(3) MSL, Peak Temp. - The Moisture Sensitivity Level rating according to the JEDEC industry standard classifications, and peak solder temperature.

(4) There may be additional marking, which relates to the logo, the lot trace code information, or the environmental category on the device.

(5) Multiple Device Markings will be inside parentheses. Only one Device Marking contained in parentheses and separated by a "~" will appear on a device. If a line is indented then it is a continuation of the previous line and the two combined represent the entire Device Marking for that device.

(6) Lead/Ball Finish - Orderable Devices may have multiple material finish options. Finish options are separated by a vertical ruled line. Lead/Ball Finish values may wrap to two lines if the finish value exceeds the maximum column width.

**Important Information and Disclaimer:** The information provided on this page represents TI's knowledge and belief as of the date that it is provided. TI bases its knowledge and belief on information provided by third parties, and makes no representation or warranty as to the accuracy of such information. Efforts are underway to better integrate information from third parties. TI has taken and continues to take reasonable steps to provide representative and accurate information but may not have conducted destructive testing or chemical analysis on incoming materials and chemicals. TI and TI suppliers consider certain information to be proprietary, and thus CAS numbers and other limited information may not be available for release.

In no event shall TI's liability arising out of such information exceed the total purchase price of the TI part(s) at issue in this document sold by TI to Customer on an annual basis.



## TAPE AND REEL INFORMATION



### QUADRANT ASSIGNMENTS FOR PIN 1 ORIENTATION IN TAPE



\*All dimensions are nominal

Device	Package Type	Package Drawing	Pins	SPQ	Reel Diameter (mm)	Reel Width W1 (mm)	A0 (mm)	B0 (mm)	K0 (mm)	P1 (mm)	W (mm)	Pin1 Quadrant
LM340MP-5.0	SOT-223	DCY	4	1000	330.0	16.4	7.0	7.5	2.2	12.0	16.0	Q3
LM340MP-5.0/NOPB	SOT-223	DCY	4	1000	330.0	16.4	7.0	7.5	2.2	12.0	16.0	Q3
LM340MPX-5.0/NOPB	SOT-223	DCY	4	2000	330.0	16.4	7.0	7.5	2.2	12.0	16.0	Q3
LM340SX-12/NOPB	DDPAK/ TO-263	KTT	3	500	330.0	24.4	10.75	14.85	5.0	16.0	24.0	Q2
LM340SX-5.0	DDPAK/ TO-263	KTT	3	500	330.0	24.4	10.75	14.85	5.0	16.0	24.0	Q2
LM340SX-5.0/NOPB	DDPAK/ TO-263	KTT	3	500	330.0	24.4	10.75	14.85	5.0	16.0	24.0	Q2
LM7805MP/NOPB	SOT-223	DCY	4	1000	330.0	16.4	7.0	7.5	2.2	12.0	16.0	Q3
LM7805SX/NOPB	DDPAK/ TO-263	KTT	3	500	330.0	24.4	10.75	14.85	5.0	16.0	24.0	Q2
LM7812SX/NOPB	DDPAK/ TO-263	KTT	3	500	330.0	24.4	10.75	14.85	5.0	16.0	24.0	Q2

**TAPE AND REEL BOX DIMENSIONS**

\*All dimensions are nominal

Device	Package Type	Package Drawing	Pins	SPQ	Length (mm)	Width (mm)	Height (mm)
LM340MP-5.0	SOT-223	DCY	4	1000	367.0	367.0	35.0
LM340MP-5.0/NOPB	SOT-223	DCY	4	1000	367.0	367.0	35.0
LM340MPX-5.0/NOPB	SOT-223	DCY	4	2000	367.0	367.0	35.0
LM340SX-12/NOPB	DDPAK/TO-263	KTT	3	500	367.0	367.0	45.0
LM340SX-5.0	DDPAK/TO-263	KTT	3	500	367.0	367.0	45.0
LM340SX-5.0/NOPB	DDPAK/TO-263	KTT	3	500	367.0	367.0	45.0
LM7805MP/NOPB	SOT-223	DCY	4	1000	367.0	367.0	35.0
LM7805SX/NOPB	DDPAK/TO-263	KTT	3	500	367.0	367.0	45.0
LM7812SX/NOPB	DDPAK/TO-263	KTT	3	500	367.0	367.0	45.0

NDE0003B



KTT0003B



TS3B (Rev F)

NDS0002A



DCY (R-PDSO-G4)

PLASTIC SMALL-OUTLINE



- NOTES: A. All linear dimensions are in millimeters (inches).  
 B. This drawing is subject to change without notice.  
 C. Body dimensions do not include mold flash or protrusion.  
 D. Falls within JEDEC TO-261 Variation AA.

DCY (R-PDSO-G4)

PLASTIC SMALL OUTLINE



- NOTES:
- A. All linear dimensions are in millimeters.
  - B. This drawing is subject to change without notice.
  - C. Publication IPC-7351 is recommended for alternate designs.
  - D. Laser cutting apertures with trapezoidal walls and also rounding corners will offer better paste release. Customers should contact their board assembly site for stencil recommendations. Refer to IPC 7525 for stencil design considerations.

NDG0003F

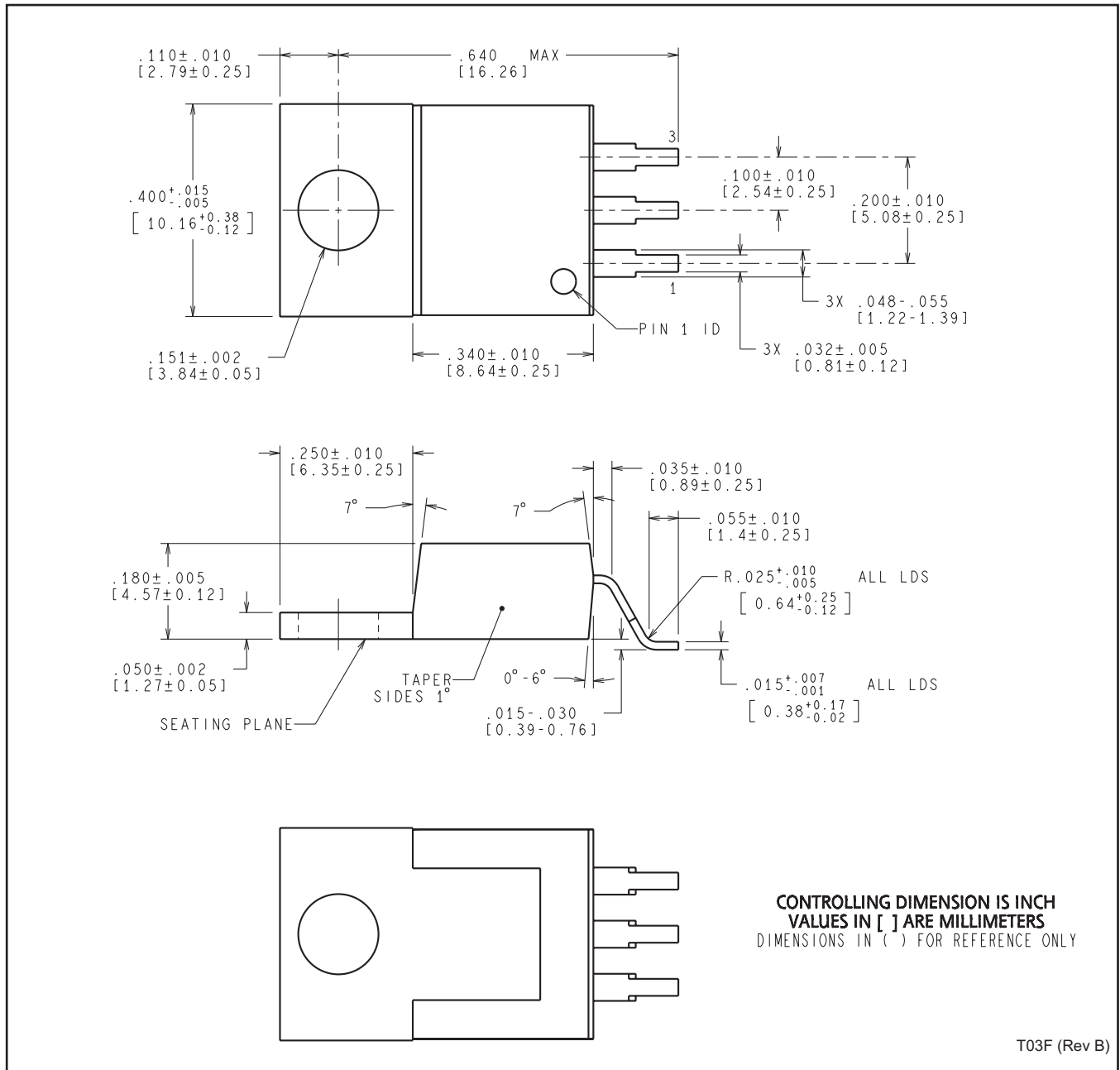

T03F (Rev B)



## IMPORTANT NOTICE FOR TI DESIGN INFORMATION AND RESOURCES

Texas Instruments Incorporated ("TI") technical, application or other design advice, services or information, including, but not limited to, reference designs and materials relating to evaluation modules, (collectively, "TI Resources") are intended to assist designers who are developing applications that incorporate TI products; by downloading, accessing or using any particular TI Resource in any way, you (individually or, if you are acting on behalf of a company, your company) agree to use it solely for this purpose and subject to the terms of this Notice.

TI's provision of TI Resources does not expand or otherwise alter TI's applicable published warranties or warranty disclaimers for TI products, and no additional obligations or liabilities arise from TI providing such TI Resources. TI reserves the right to make corrections, enhancements, improvements and other changes to its TI Resources.

You understand and agree that you remain responsible for using your independent analysis, evaluation and judgment in designing your applications and that you have full and exclusive responsibility to assure the safety of your applications and compliance of your applications (and of all TI products used in or for your applications) with all applicable regulations, laws and other applicable requirements. You represent that, with respect to your applications, you have all the necessary expertise to create and implement safeguards that (1) anticipate dangerous consequences of failures, (2) monitor failures and their consequences, and (3) lessen the likelihood of failures that might cause harm and take appropriate actions. You agree that prior to using or distributing any applications that include TI products, you will thoroughly test such applications and the functionality of such TI products as used in such applications. TI has not conducted any testing other than that specifically described in the published documentation for a particular TI Resource.

You are authorized to use, copy and modify any individual TI Resource only in connection with the development of applications that include the TI product(s) identified in such TI Resource. NO OTHER LICENSE, EXPRESS OR IMPLIED, BY ESTOPPEL OR OTHERWISE TO ANY OTHER TI INTELLECTUAL PROPERTY RIGHT, AND NO LICENSE TO ANY TECHNOLOGY OR INTELLECTUAL PROPERTY RIGHT OF TI OR ANY THIRD PARTY IS GRANTED HEREIN, including but not limited to any patent right, copyright, mask work right, or other intellectual property right relating to any combination, machine, or process in which TI products or services are used. Information regarding or referencing third-party products or services does not constitute a license to use such products or services, or a warranty or endorsement thereof. Use of TI Resources may require a license from a third party under the patents or other intellectual property of the third party, or a license from TI under the patents or other intellectual property of TI.

TI RESOURCES ARE PROVIDED "AS IS" AND WITH ALL FAULTS. TI DISCLAIMS ALL OTHER WARRANTIES OR REPRESENTATIONS, EXPRESS OR IMPLIED, REGARDING TI RESOURCES OR USE THEREOF, INCLUDING BUT NOT LIMITED TO ACCURACY OR COMPLETENESS, TITLE, ANY EPIDEMIC FAILURE WARRANTY AND ANY IMPLIED WARRANTIES OF MERCHANTABILITY, FITNESS FOR A PARTICULAR PURPOSE, AND NON-INFRINGEMENT OF ANY THIRD PARTY INTELLECTUAL PROPERTY RIGHTS.

TI SHALL NOT BE LIABLE FOR AND SHALL NOT DEFEND OR INDEMNIFY YOU AGAINST ANY CLAIM, INCLUDING BUT NOT LIMITED TO ANY INFRINGEMENT CLAIM THAT RELATES TO OR IS BASED ON ANY COMBINATION OF PRODUCTS EVEN IF DESCRIBED IN TI RESOURCES OR OTHERWISE. IN NO EVENT SHALL TI BE LIABLE FOR ANY ACTUAL, DIRECT, SPECIAL, COLLATERAL, INDIRECT, PUNITIVE, INCIDENTAL, CONSEQUENTIAL OR EXEMPLARY DAMAGES IN CONNECTION WITH OR ARISING OUT OF TI RESOURCES OR USE THEREOF, AND REGARDLESS OF WHETHER TI HAS BEEN ADVISED OF THE POSSIBILITY OF SUCH DAMAGES.

You agree to fully indemnify TI and its representatives against any damages, costs, losses, and/or liabilities arising out of your non-compliance with the terms and provisions of this Notice.

This Notice applies to TI Resources. Additional terms apply to the use and purchase of certain types of materials, TI products and services. These include; without limitation, TI's standard terms for semiconductor products (<http://www.ti.com/sc/docs/stdterms.htm>), [evaluation modules](#), and [samples](http://www.ti.com/sc/docs/sampterm.htm) (<http://www.ti.com/sc/docs/sampterm.htm>).

Mailing Address: Texas Instruments, Post Office Box 655303, Dallas, Texas 75265  
Copyright © 2017, Texas Instruments Incorporated