

DS7820A/DS8820A Dual Line Receiver

General Description

The DS7820A and the DS8820A are improved performance digital line receivers with two completely independent units fabricated on a single silicon chip. Intended for use with digital systems connected by twisted pair lines, they have a differential input designed to reject large common mode signals while responding to small differential signals. The output is directly compatible with TTL or LS integrated circuits.

The response time can be controlled with an external capacitor to reject input noise spikes. The output state is a logic "1" for both inputs open. Termination resistors for the twisted pair line are also included in the circuit. Both the DS7820A and the DS8820A are specified, worst case, over their full

operating temperature range (-55°C to $+125^{\circ}\text{C}$ and 0°C to 70°C respectively), over the entire input voltage range, for $\pm 10\%$ supply voltage variations.

Features

- Operation from a single +5V logic supply
- Input voltage range of $\pm 15\text{V}$
- Strobe low forces output to "1" state
- High input resistance
- Fanout of ten with TTL integrated circuits
- Outputs can be wire OR'ed
- Series 54/74 compatible

Connection Diagram

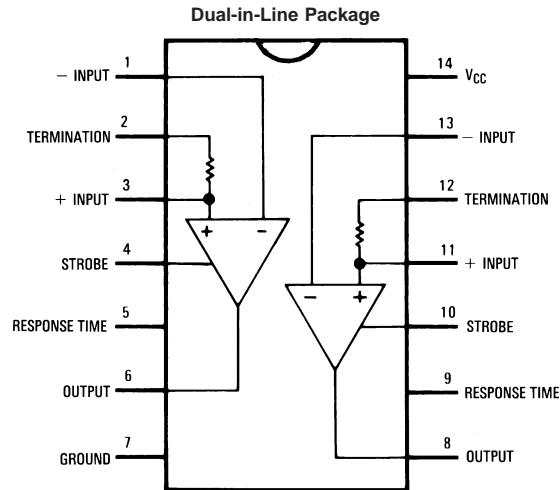

DS005797-2

Note 1: Pin 7 connected to bottom of cavity package.

Top View
Order Number DS7820AJ or DS8820AN See NS Package Number J14A or N14A
For Complete Military 883 Specifications, See RETS Data Sheet.
Order Number DS7820AJ/883
See NS Package Number J14A or W14B

Absolute Maximum Ratings (Note 3)

If Military/Aerospace specified devices are required, please contact the National Semiconductor Sales Office/Distributors for availability and specifications.

Supply Voltage	8.0V
Common-Mode Voltage	±20V
Differential Input Voltage	±20V
Strobe Voltage	8.0V
Output Sink Current	50 mA
Storage Temperature Range	-65°C to 150°C
Maximum Power Dissipation (Note 2) at 25°C	
Cavity Package	1308 mW
Molded Package	1207 mW

Lead Temperature (Soldering, 4 sec.)

260°C

Operating Conditions

	Min	Max	Units
Supply Voltage (V_{CC})			
DS7820A	4.5	5.5	V
DS8820A	4.75	5.25	V
Temperature (T_A)			
DS7820A	-55	+125	°C
DS8820A	0	+70	°C

Note 2: Derate cavity package 8.7 mW/°C above 25°C; derate molded package 9.7 mW/°C above 25°C.

Electrical Characteristics (Notes 4, 5, 6)

Symbol	Parameter	Conditions	Min	Typ	Max	Units	
V_{TH}	Differential Threshold Voltage	$I_{OUT} = -400 \mu A$, $V_{OUT} \geq 2.5V$	$-3V \leq V_{CM} \leq +3V$		0.06	0.5	V
			$-15V \leq V_{CM} \leq +15V$		0.06	1.0	V
		$I_{OUT} = +16 mA$, $V_{OUT} \leq 0.4V$	$-3V \leq V_{CM} \leq +3V$		-0.08	-0.5	V
			$-15V \leq V_{CM} \leq +15V$		-0.08	-1.0	V
R_{I-}	Inverting Input Resistance	$-15V \leq V_{CM} \leq +15V$	3.6	5		k Ω	
R_{I+}	Non-Inverting Input Resistance	$-15V \leq V_{CM} \leq +15V$	1.8	2.5		k Ω	
R_T	Line Termination Resistance	$T_A = 25^\circ C$	120	170	250	Ω	
I_{I-}	Inverting Input Current	$V_{CM} = 15V$		3.0	4.2	mA	
		$V_{CM} = 0V$		0	-0.5	mA	
		$V_{CM} = -15V$		-3.0	-4.2	mA	
I_{I+}	Non-Inverting Input Current	$V_{CM} = 15V$		5.0	7.0	mA	
		$V_{CM} = 0V$		-1.0	-1.6	mA	
		$V_{CM} = -15V$		-7.0	-9.8	mA	
I_{CC}	Power Supply Current One Side Only	$I_{OUT} = \text{Logical "0"}$	$V_{DIFF} = -1V$, $V_{CM} = 15V$		3.9	6.0	mA
			$V_{CM} = -15V$		9.2	14.0	mA
		$V_{DIFF} = -0.5V$, $V_{CM} = 0V$		6.5	10.2	mA	
V_{OH}	Logical "1" Output Voltage	$I_{OUT} = -400 \mu A$, $V_{DIFF} = 1V$	2.5	4.0	5.5	V	
V_{OL}	Logical "0" Output Voltage	$I_{OUT} = +16 mA$, $V_{DIFF} = -1V$	0	0.22	0.4	V	
V_{SH}	Logical "1" Strobe Input Voltage	$I_{OUT} = +16 mA$, $V_{OUT} \leq 0.4V$, $V_{DIFF} = -3V$	2.1			V	
V_{SL}	Logical "0" Strobe Input Voltage	$I_{OUT} = -400 \mu A$, $V_{OUT} \geq 2.5V$, $V_{DIFF} = -3V$			0.9	V	
I_{SH}	Logical "1" Strobe Input Current	$V_{STROBE} = 5.5V$, $V_{DIFF} = 3V$		0.01	5.0	μA	
I_{SL}	Logical "0" Strobe Input Current	$V_{STROBE} = 0.4V$, $V_{DIFF} = -3V$		-1.0	-1.4	mA	
I_{SC}	Output Short Circuit Current	$V_O = 0V$, $V_{CC} = 5.5V$, $V_{STROBE} = 0V$	-2.8	-4.5	-6.7	mA	

Note 3: "Absolute Maximum Ratings" are those values beyond which the safety of the device cannot be guaranteed. Except for "Operating Temperature Range" they are not meant to imply that the devices should be operated at these limits. The table of "Electrical Characteristics" provides conditions for actual device operation.

Note 4: These specifications apply for $4.5V \leq V_{CC} \leq 5.5V$, $-15V \leq V_{CM} \leq 15V$ and $-55^\circ C \leq T_A \leq +125^\circ C$ for the DS7820A or $4.75V \leq V_{CC} \leq 5.25V$, $0^\circ C \leq T_A \leq +70^\circ C$ for the DS8820A unless otherwise specified. Typical values given are for $V_{CC} = 5.0V$, $T_A = 25^\circ C$ and $V_{CM} = 0V$ unless stated differently.

Note 5: All currents into device pins shown as positive, out of device pins as negative, all voltages referenced to ground unless otherwise noted. All values shown as max or min on absolute value basis.

Note 6: Only one output at a time should be shorted.

Switching Characteristics

$T_A = 25^\circ\text{C}$, $V_{CC} = 5\text{V}$, unless otherwise noted

Symbol	Parameter	Conditions	Min	Typ	Max	Units
t_{pd0}	Propagation Delay, Differential Input to "0" Output	$R_L = 400\ \Omega$, $C_L = 15\ \text{pF}$, see Figure 1		30	45	ns
t_{pd1}	Propagation Delay, Differential Input to "1" Output			27	40	ns
t_{pd0}	Propagation Delay, Strobe Input to "0" Output			16	25	ns
t_{pd1}	Propagation Delay, Strobe Input to "1" Output			18	30	ns

AC Test Circuit and Waveforms

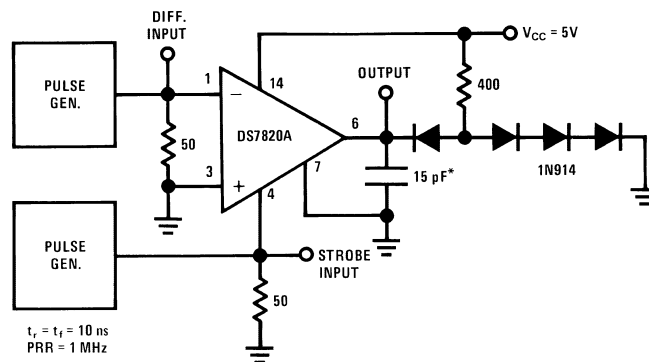

DS005797-7

Note 7: *Includes Jig and Probe Capacitance

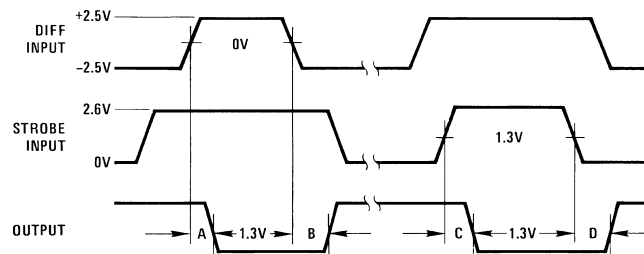

DS005797-8

- A = Differential Input to "0" Output
- B = Differential Input to "1" Output
- C = Strobe Input to "0" Output
- D = Strobe Input to "1" Output

FIGURE 1.

Typical Performance Characteristics

Supply Voltage Sensitivity

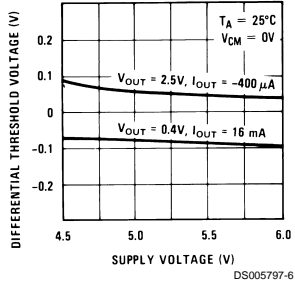

Common-Mode Voltage Sensitivity

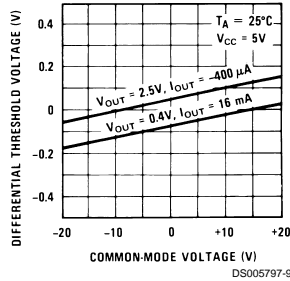

Temperature Sensitivity

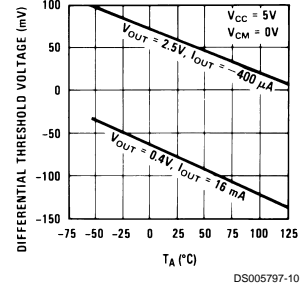

Transfer Function

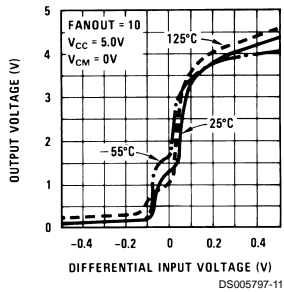

Termination Resistance

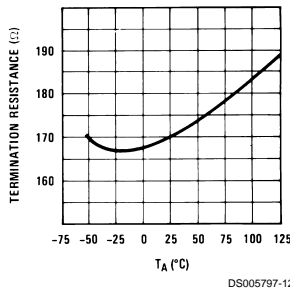

Input Characteristics

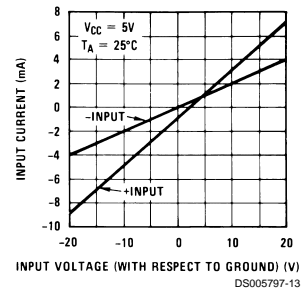

Power Supply Current

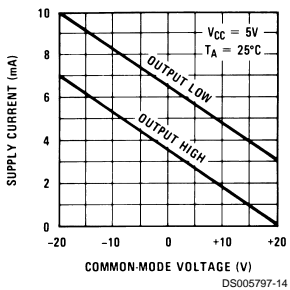

Internal Power Dissipation

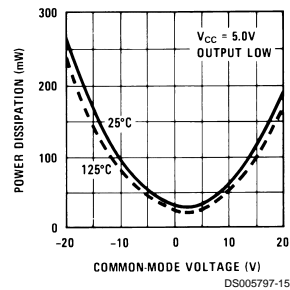

Output Voltage Levels

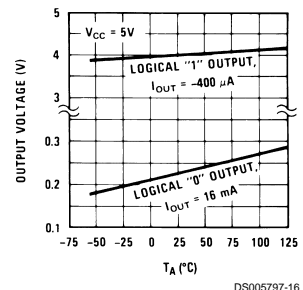

Differential Input Delays

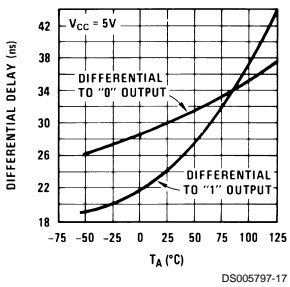

Strobe Delays

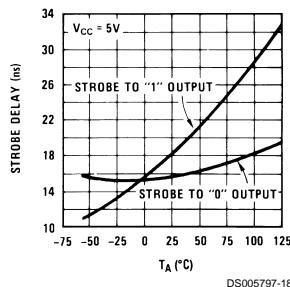

Noise Rejection

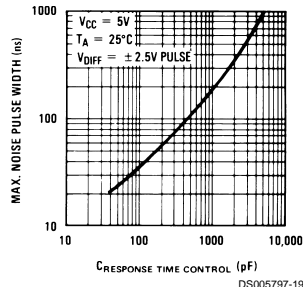

Schematic Diagram

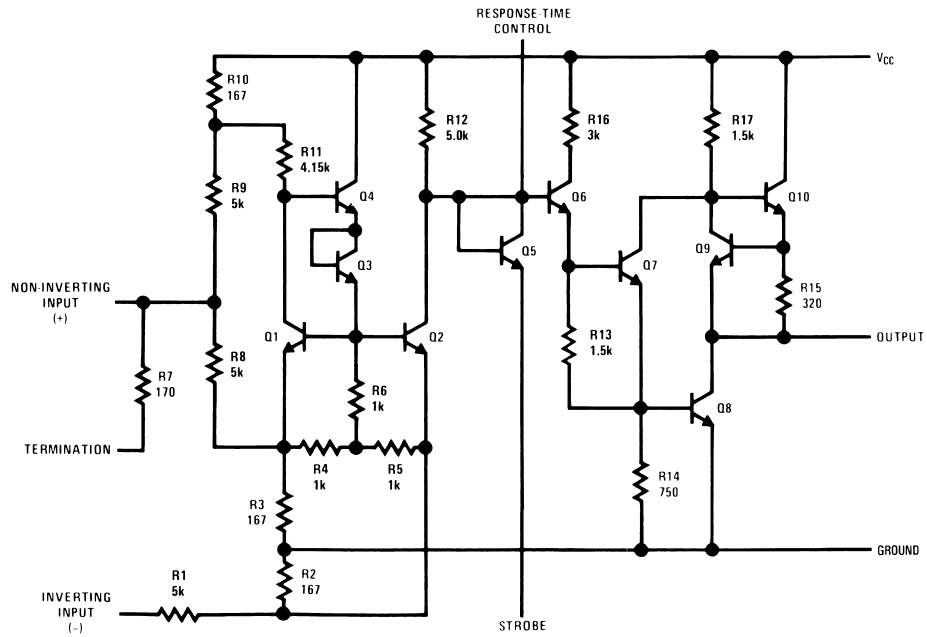

Note 8: Schematic shows one-half of unit.

DS005797-1

Typical Applications

Differential Line Driver and Receiver

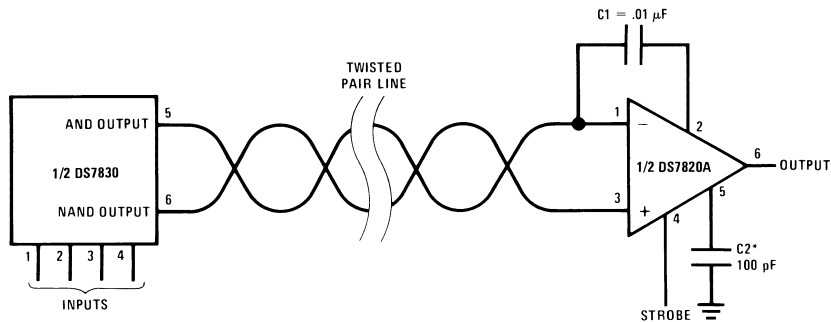

Note 9: Optional to control response time.

DS005797-3

Single Ended (EIA-RS232C) Receiver with Hysteresis

Typical Applications (Continued)

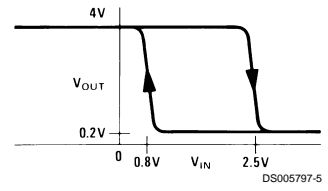
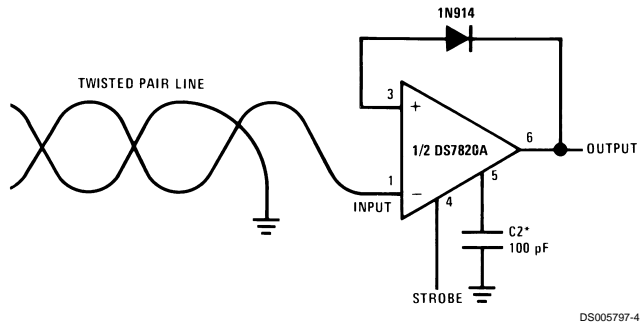

(Output = "1" for Open Input)

Physical Dimensions inches (millimeters) unless otherwise noted

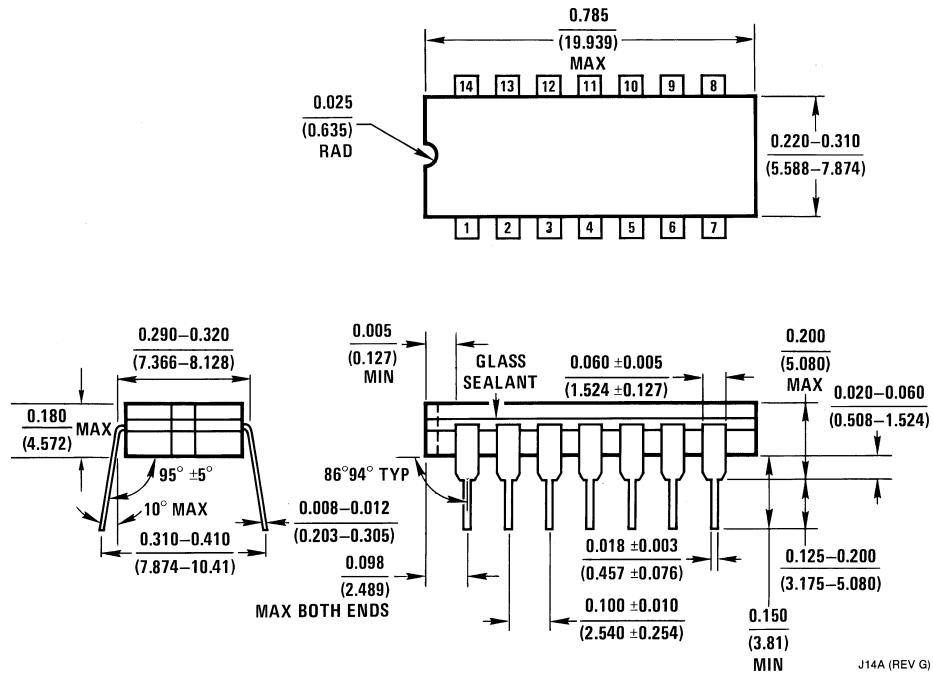

Ceramic Dual-In-Line Package (J)
Order Number DS7820AJ or DS7820AJ/883
NS Package Number J14A

J14A (REV G)

Physical Dimensions inches (millimeters) unless otherwise noted (Continued)

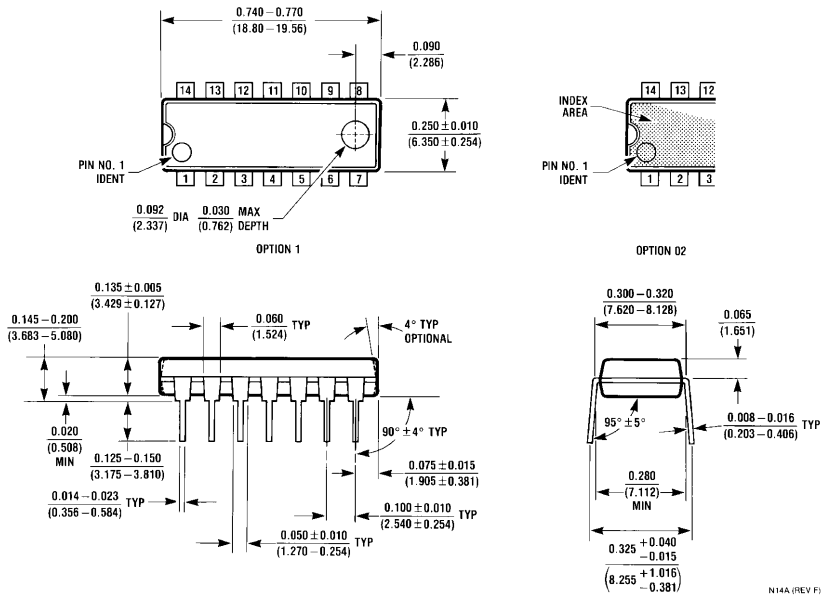

Molded Dual-In-Line Package (N)
Order Number DS8820AN
NS Package Number N14A

LIFE SUPPORT POLICY

NATIONAL'S PRODUCTS ARE NOT AUTHORIZED FOR USE AS CRITICAL COMPONENTS IN LIFE SUPPORT DEVICES OR SYSTEMS WITHOUT THE EXPRESS WRITTEN APPROVAL OF THE PRESIDENT AND GENERAL COUNSEL OF NATIONAL SEMICONDUCTOR CORPORATION. As used herein:

1. Life support devices or systems are devices or systems which, (a) are intended for surgical implant into the body, or (b) support or sustain life, and whose failure to perform when properly used in accordance with instructions for use provided in the labeling, can be reasonably expected to result in a significant injury to the user.
2. A critical component is any component of a life support device or system whose failure to perform can be reasonably expected to cause the failure of the life support device or system, or to affect its safety or effectiveness.

 <p>National Semiconductor Corporation Americas Tel: 1-800-272-9959 Fax: 1-800-737-7018 Email: support@nsc.com</p>	<p>National Semiconductor Europe Fax: +49 (0) 1 80-530 85 86 Email: europe.support@nsc.com Deutsch Tel: +49 (0) 1 80-530 85 85 English Tel: +49 (0) 1 80-532 78 32 Français Tel: +49 (0) 1 80-532 93 58 Italiano Tel: +49 (0) 1 80-534 16 80</p>	<p>National Semiconductor Asia Pacific Customer Response Group Tel: 65-2544466 Fax: 65-2504466 Email: sea.support@nsc.com</p>	<p>National Semiconductor Japan Ltd. Tel: 81-3-5639-7560 Fax: 81-3-5639-7507</p>
--	---	---	---

www.national.com

National does not assume any responsibility for use of any circuitry described, no circuit patent licenses are implied and National reserves the right at any time without notice to change said circuitry and specifications.